



Transport
Canada

Transports
Canada



TP 511E

SAFE BOATING GUIDE

Safety Tips and Requirements for Pleasure Craft



www.tc.gc.ca/boatingsafety

Canada

TABLE OF CONTENTS

Lake Laberge, YUKON

© Her Majesty the Queen in Right of Canada, represented by the Minister of Transport, 2014.

Transport Canada grants permission to copy and/or reproduce the contents of this publication for personal and public non-commercial use. Users must reproduce the materials accurately, identify Transport Canada as the source and not present theirs as an official version, or as having been produced with the help or the endorsement of Transport Canada.

To request permission to reproduce materials from this publication for commercial purposes, please complete the following web form:
www.tc.gc.ca/eng/crown-copyright-request-614.html

Or contact: TCcopyright-droitdauteurTC@tc.gc.ca

TP 511E (04/2014)
Catalogue No T34-24/2014E
ISSN: 1927-0623

Cette publication est aussi disponible en français sous le titre «Guide de sécurité nautique.»

■	INTRODUCTION	4
■	GETTING STARTED	7
	CONSTRUCTION REQUIREMENTS	8
	LICENSING AND REGISTRATION	11
	BOATING SAFETY KNOWLEDGE	12
	SAFETY EQUIPMENT REQUIREMENTS	15
■	BEFORE YOU GO	35
	INSPECT YOUR BOAT	36
	MONITOR THE WEATHER	36
	MAKE AND FILE A SAIL PLAN	36
	CARRY AND USE OFFICIAL NAUTICAL CHARTS AND PUBLICATIONS	37
	PLAN TO AVOID LOCAL HAZARDS	38
	FUEL SAFELY	38
	BE AWARE OF CARBON MONOXIDE DANGERS	39
	REDUCE THE RISKS OF EXPLOSION	40
	LOAD YOUR BOAT PROPERLY	41
	HAVE A PLEASURE CRAFT COURTESY CHECK	41
■	ON THE WATER	43
	KNOW THE RULES OF THE ROAD AND SAFETY ON THE WATER	44
	HELP ENSURE SMALL VESSEL AND FACILITY SECURITY	50
	RESPECT AND PROTECT CANADA'S WATERWAYS	52
	KNOW THE RESTRICTIONS THAT APPLY	54
	BE READY TO COMPLY	56
■	IN AN EMERGENCY	59
	COMMUNICATE EFFICIENTLY	60
	BE PREPARED TO REACT TO AN EMERGENCY	63
■	CONTACT INFORMATION AND REFERENCES	67
■	REFERENCE CARDS	72

INTRODUCTION

Welcome to the *SAFE BOATING GUIDE*. Transport Canada publishes this resource to make sure that you know the regulations that apply to boating and that you learn more about safe and responsible boating practices.

Boating is fun, but about 100 people die and many more get seriously injured every year in boating incidents. Most boating deaths and injuries can be avoided.

Cartwright Village, NEWFOUNDLAND

KNOW THE REGULATIONS

The *Canada Shipping Act, 2001* is the law that, along with its regulations, governs pleasure craft. It includes the requirements that govern the conduct of all vessels. The regulations affecting pleasure craft under this law include:

- *Competency of Operators of Pleasure Craft Regulations;*
- *Small Vessel Regulations;*
- *Collision Regulations;*
- *Vessel Operation Restriction Regulations;* and
- *Vessel Pollution and Dangerous Chemicals Regulations.*

Canada's Criminal Code also applies to boating. Activities like operating a boat while impaired, failing to stop at the scene of an accident and operating an unseaworthy boat are crimes.

REMEMBER: Because boating laws change from time to time, make sure you have the most current information. If the SAFE BOATING GUIDE differs from the regulations, always follow the regulatory text. To learn more about regulations, use the direct links in the CONTACT INFORMATION AND REFERENCES section of this guide.

Regulations set a minimum safety standard. Following them or an even higher standard will help make every trip a safe one.

Note: As the owner or operator of a pleasure craft, you may also be required to comply with additional regulations and/or laws that are specific to a sector (e.g. the *Canada National Marine Conservation Areas Act*).

Use this guide as a starting point to safe boating

While this guide offers a basic overview of boating safety, it should not be your only source of information. No matter your age or experience, you should take a boating safety course. Visit our website for a complete list of [Transport Canada accredited course providers](#).

REMEMBER: This is not a study guide for the Pleasure Craft Operator Card course or test.

To buy a training manual for the test, contact an [accredited course provider](#).

You will find more information about the regulations that apply to pleasure boating as well as boating safety tips [on our website](#). You may also call the Boating Safety Infoline at 1-800-267-6687.



Rocher Percé, GASPÉ PENINSULA

GETTING STARTED

Do you want to start boating but you are not sure what you need to do to get a boat ready for Canada's waterways? This section will guide you through getting your boat out on the water for the first time and explain how to make sure that you are ready to operate it safely.



USEFUL DEFINITIONS

Pleasure craft

A pleasure craft is any boat that you use only for pleasure activities like fishing, water sports and entertaining friends. It also includes a boat you use for subsistence hunting and fishing or for daily living (for example, in remote areas, going from one village to another).

Non-Pleasure Craft

A non-pleasure craft is a vessel that you use for work or commercial activities. You must meet the requirements for non-pleasure craft any time you use your pleasure craft for non-pleasure activities. If you want to know how to operate a passenger vessel, workboat, commercial fishing vessel or any other non-pleasure craft, visit www.tc.gc.ca/marinesafety or contact your local Transport Canada Centre.

PFD

PFD refers to personal flotation device.

In this guide:

- **Boat** means pleasure craft.
- **Vessel** refers to pleasure craft as well as non-pleasure craft.

CONSTRUCTION REQUIREMENTS

Small vessels that are equipped or designed to be equipped with a motor (including pleasure craft up to 24 m or 78'9") and operated in Canada must comply with Part 7 of the *Small Vessel Regulations* and Transport Canada's *Construction Standards for Small Vessels* (TP 1332E). If you are selling, importing, building, rebuilding or operating such a vessel in Canada, you must make sure it meets these construction requirements.

Pleasure craft over 24 m (78'9") must be built or rebuilt according to recommended practices and standards appropriate for that type of vessel. These requirements are published by a marine classification society, standards development organization, government agency, or industrial or trade association.

Compliance Notices

Compliance notices are the manufacturer's or importer's confirmation that the vessel is built according to the *Small Vessel Regulations* construction requirements (see CONSTRUCTION REQUIREMENTS section). Before attaching a compliance notice to a vessel, a manufacturer or importer must provide Transport Canada with a declaration of conformity for the vessel.

The *Small Vessel Regulations* require, with a few exceptions, that all pleasure craft of less than 24 metres, that are or can be fitted with a motor, have a compliance notice affixed to them in a location visible from the helm.





Although no law prohibits you from having other types of compliance notices affixed to your vessel, you **must** have an affixed Canadian compliance notice if your boat was bought in Canada.

Compliance notices for pleasure craft up to 6 m (19'8") also have information on recommended maximum safe limits. These recommended maximum safe limits will tell you:

- what motor sizes are safe (outboard powered vessels only);
- how many people can be on board; and
- how much weight the boat can hold.

**CANADIAN COMPLIANCE NOTICE
AVIS DE CONFORMITÉ CANADIEN**

**MAXIMUM RECOMMENDED SAFE LIMITS
LIMITES MAXIMALES DE SÉCURITÉ RECOMMANDÉES**

	XX	XXXX kg XXXX lbs/lb
 +  + 		XXXX kg XXXX lbs/lb
	XX kW XX HP	XXXX kg XXXX lbs/lb

THE MAXIMUM RECOMMENDED SAFE LIMITS MIGHT HAVE TO BE REDUCED IN ADVERSE SEA AND WEATHER CONDITIONS.

LES LIMITES MAXIMALES DE SECURITE RECOMMANDEES PEUVENT DEVOIR ETRE REDUITES DANS LES CONDITIONS DE MER ET DES CONDITIONS METEOROLOGIQUES DIFFICILES.

* ADDITIONAL INFORMATION

SAFEBOAT COMPANY INC. (MIC)

CITY, PROVINCE, COUNTRY

MODEL / MODÈLE: RUNABOUT555X

THE MANUFACTURER DECLARES THAT THIS PRODUCT COMPLIES WITH THE CONSTRUCTION REQUIREMENTS OF THE SMALL VESSEL REGULATIONS AS THEY READ ON THE DAY ON WHICH THE CONSTRUCTION OF THE VESSEL WAS STARTED OR ON THE DAY ON WHICH THE VESSEL WAS IMPORTED.

LE FABRICANT ATTESTE QUE CE PRODUIT EST CONFORME AUX EXIGENCES DE CONSTRUCTION DU REGLEMENT SUR LES PETITS BATIMENTS EN VIGUEUR A LA DATE DU DEBUT DE SA CONSTRUCTION OU DE SON IMPORTATION.

REMEMBER: This information applies only in good sea and weather conditions. The number of people you may carry safely depends on the type of boat, the waterway you are using (i.e. open water, inland waterway, etc.), and weather and water conditions. As an operator, you must know and respect your boat's limits.

Hull Serial Number

All pleasure craft made in Canada, or imported into Canada after August 1, 1981 (with or without a motor), must have a hull serial number. This number helps to find lost or stolen boats and boats that are subject to a recall. The hull serial number must be permanently marked on the outside upper starboard (right side) corner of the transom (the boat's rear, flat end – above the waterline), or as close to that area as possible. It is 12 digits long and each character must be at least 6 mm (1/4") in height and width.

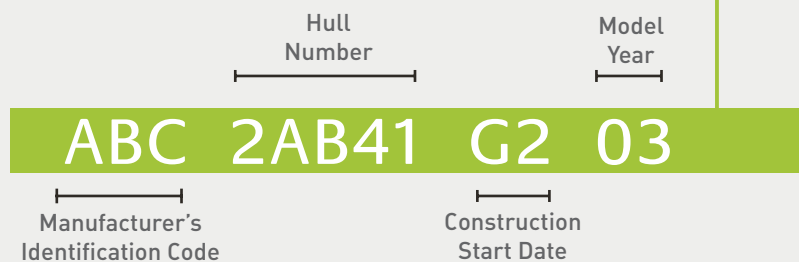

Things to Know Before Buying a Boat

Buying a New Boat

If you are buying a new boat in Canada, make sure it has:

- a [hull serial number](#);
- a [Canadian compliance notice](#), if it applies; and
- a copy of the [declaration of conformity](#).

If you see a new boat for sale that does not have the required hull serial number and Canadian compliance notice (if it applies), ask the seller to get them for you **before** you buy. It is the manufacturers' and importers' responsibility to demonstrate that the boats that they sell in Canada meet the Canadian construction requirements.

Buying a Used Boat

If you are thinking about buying a used boat, the first thing you should do is make sure that it meets the construction requirements that were in force when it was built. A good way to do this is to hire a marine surveyor to examine the boat, who will give you a fair opinion on the boat's current condition and will let you know what changes (if any) will need to be made to bring the boat up to standard.

If you have already bought a boat that does not have the required hull serial number or compliance notice, you should request one from the original manufacturer or importer. If you are unable to obtain them, you do not need to take additional actions. However, make sure you are able to prove that you have made reasonable attempts to obtain them.

REMEMBER: A Canadian compliance notice indicates that the boat met the construction requirements at the time it was built. Changes to the boat over time may mean that the compliance notice is no longer valid. Once you own the boat, you must make sure that it meets the standard when you operate it on the water — so get all the facts before you buy.

Buying a Boat From Another Country

If you are buying a boat from another country, remember that:

Construction requirements for pleasure craft differ from country to country. Make sure that the boat meets the [Small Vessel Regulations](#) construction requirements that are in force on the day it entered Canada. If the boat does not meet these requirements, make sure that you can modify the boat to meet them before you operate it.

Other requirements you must meet are:

- **Import requirements.** When you plan to bring the boat to Canada, the [Canada Border Services Agency \(CBSA\)](#) requires that you have specific documents, as well as information on the boat and the seller to confirm the sale and assess the duties and taxes on the boat. Before buying the boat, [visit the CBSA online](#) or contact them to find out what you will need from the seller to bring the boat to Canada.

If you are towing the boat on a trailer, [contact the CBSA](#) to learn more about the requirements you should meet.

- **Export requirements.** Contact the appropriate authorities in the country where you plan to buy the boat (and the trailer if you are buying one) to find out if any export requirements apply.

Buying a Trailer

A trailer is considered a motor vehicle. This means that different requirements apply to it than to your boat. If you plan to buy a trailer, contact your [provincial or territorial transportation office](#) to learn about any requirements that may apply.

Things to Know Before Building a Boat

If you decide to build or rebuild a pleasure craft, it must meet or exceed the construction requirements of the [Small Vessel Regulations](#) and Transport Canada's [Construction Standards for Small Vessels](#) (TP 1332E).

Building a Boat You Are Planning to Sell

If you plan to sell the boat you are building, you must:

- apply to Transport Canada for a manufacturer's identification code (MIC);
- provide Transport Canada with a declaration of conformity and give a copy to the reseller or the end user;
- place a compliance notice on the boat;
- place a hull serial number on the boat.

Building a Boat For Your Personal Use

If the boat will be for your own personal use, you are not required to attach a compliance notice and a hull serial number. But remember, it must meet or exceed construction requirements.

LICENSING AND REGISTRATION

A Canadian pleasure craft may be licensed or registered.

Pleasure Craft Licence

If you operate or keep your boat mostly in Canada, and it is powered by one or more motors adding up to 7.5 kW (10 hp) or more, **you must get it licensed**, unless you register it. You must also license dinghies or tenders you carry aboard or tow behind a larger boat.

A pleasure craft licence is a document giving your boat a unique licence number that is valid for 10 years. The Pleasure Craft Licensing System allows Search and Rescue personnel to access information about your boat 24 hours a day, seven days a week in the event of an emergency. This could mean the difference between life and death! If your boat does not need a pleasure craft licence, you can choose to get one for safety reasons.

How Can You Get a Licence?

Application forms are available on our website.

- Follow the instructions included in the form to fill out the appropriate sections.
- Attach all the required documents to the completed signed form.
- Mail the documents to the Pleasure Craft Licensing Centre at the mailing address indicated in the instructions.

REMEMBER: This is the only way to complete the pleasure craft licence application process. You cannot complete the process in person nor by sending your information to your local Transport Canada office. Once you get your pleasure craft licence, **keep a copy on board.**

What a Licence Number Looks Like?



You must display the pleasure craft licence number on your boat:

- on both sides of the bow;
- above the waterline;
- as far forward as practical; and
- where it is easy to see.

The characters must be:

- in block letters;
- at least 7.5 cm (3") high; and
- of a colour that contrasts with the background.

Is a Licence a Proof of Ownership?

A pleasure craft licence does not prove ownership. When entering another country, be sure to have proof of ownership for your boat along with its pleasure craft licence, including documents for dinghies or tenders aboard or towed behind a larger boat. Not having the proper documents on board can result in delays or trouble clearing customs, or even a fine.

Vessel Registration

Although you are no longer required to register pleasure craft over 15 gross tons, you can still choose to do so.

What a Vessel Registration Looks Like?



Why Should You Register Your Boat?

Registration gives you some important benefits, which include:

- proof of ownership (legal title) for your boat;
- the right to fly the Canadian flag;
- a unique name and official number for your boat; and
- the right to use your boat as security for a marine mortgage.

Is a Vessel Registration a Proof of Ownership?

Yes. It is a good idea to register any boat you plan to operate outside of Canada since you will have to prove ownership at international borders.

To learn more about registering your boat and the costs associated with it, visit [Transport Canada's Vessel Registration Office](#) online.

BOATING SAFETY KNOWLEDGE

Proof of Competency

Going out on the water requires basic boating safety knowledge and a good understanding of the "rules of the road" for Canadian waterways. That's why **everyone** who operates a motorized pleasure craft must carry proof of competency on board. This includes all types of motorized boats, no matter their size or horsepower of the engine (this includes small boats with electric motors.)

REMEMBER: Proof of competency is not required in the waters of the Northwest Territories and Nunavut.

What are the Accepted Forms of Proof of Competency?

Proof of competency can be any of the following:

- a Pleasure Craft Operator Card;
- proof of having passed a boating safety course in Canada before April 1, 1999;
- a specified marine certificate; or
- a completed rental boat safety checklist (good only for rental period).

Get Your Pleasure Craft Operator Card!



You can get your Pleasure Craft Operator Card by passing a boating safety test available through a Transport Canada [accredited course provider](#). These course providers help recreational boaters gain basic boating safety knowledge through flexible education and testing options including classroom, Internet, and self study.

Transport Canada (TC) recommends taking a boating safety course as the best way to prepare for the test. Taking a course, while not required, is a small investment that has a big payoff: it will make you more aware of safe boating practices, prevention measures, and practical ways to reduce risks.

The course itself covers a full range of basic boating information such as:

- the minimum safety equipment required on board your boat;
- what Canadian buoys look like and what they mean;
- how to share waterways;
- a review of regulations that relate to pleasure boating; and
- how to respond in an emergency.

Boating safety course and test services are available only through [accredited private-sector course providers](#) listed on our website.

What if You Rent a Boat?

If you plan to rent a boat and you do not already have proof of competency (such as a Pleasure Craft Operator Card or specified marine certificate), you may complete the rental boat safety checklist to meet the requirement. The rental agency will use the checklist as the basis for providing you with a basic safety orientation to the boat, its equipment and features, and information about any hazards in the local waterways. Both parties (rental agency and the boat operator) must sign the checklist, and as the boat operator, you must carry it on board. It serves as proof of competency for the rental period only.

Replace Your Lost or Damaged Pleasure Craft Operator Card

The Pleasure Craft Operator Card is good for life. Remember to make a photocopy of your card as soon as you get it so you can have it replaced if you lose it. To replace your lost or damaged Pleasure Craft Operator Card, you will need to contact the course provider who issued it.

Please note:

- Only currently [accredited course providers](#) may issue replacement cards.
- Course providers charge a fee for replacing Pleasure Craft Operator Cards.

Transport Canada can help you if:

- you don't know the name of your original course provider;
- the course provider is no longer in business; or
- the course provider is suspended.

Simply call the Boating Safety Infoline at 1-800-267-6687. An agent will look up your name in a national database of card holders and tell you what you need to do next.

Age and Horsepower Restrictions

Horsepower restrictions apply to operators under 16 years of age.

REMEMBER: Age and horsepower restrictions do not apply in the waters of the Northwest Territories and Nunavut.

Are you old enough to operate a motorized boat without direct supervision?

AGE	HORSEPOWER RESTRICTIONS
Under 12 years of age with no direct supervision*	May operate a boat with up to 7.5 kW (10 hp)
Ages 12 to under 16 with no direct supervision	May operate a boat with up to 30 kW (40 hp)
Under 16 years of age, regardless of supervision	May not operate a personal watercraft
16 years of age or older	No horsepower restrictions

*Direct supervision means a person (16 years of age or older) is in the boat and directly supervising the operator.

REMEMBER: Youth must also carry proof of competency to operate any motorized boat, supervised or not.

Carry Your Documents



When heading out in your motorized boat, make sure to bring on board:

- Proof of competency
- Personal identification
- Pleasure craft licence (for 10hp or more)

SAFETY EQUIPMENT REQUIREMENTS

You **must** have the right equipment on board. If something goes wrong on the water, you will be much better prepared to deal with it if you have the right equipment on board, if it is in good working order and if everyone can find it and use it. Remember that the best protection you can give yourself on the water is to always wear your lifejacket or your PFD.

All safety equipment on board must be:

- in good working order;
- always easy to reach (so that it can be used in an emergency); and
- maintained and replaced in accordance with the manufacturer's instructions or recommendations.

In Canada, the safety equipment required on board depends on the type and length of your boat. You can find the length of your boat:

- by reading the manufacturer's product information; or
- by measuring it yourself (from the front outside surface of the hull shell to the back outside surface of the hull shell – bow to stern).

REMEMBER: These equipment requirements **apply only to pleasure craft** and are the same whether you own, rent or borrow the boat. This includes typical boats like power boats, sail boats and personal watercraft, as well as less common boats like airboats, air cushion vehicles (hovercraft) and wing in ground effect vessels that are used only for recreation. They also apply when using kiteboards.

These requirements **do not apply to inflatable self-propelled water toys**. These toys are not designed for use in open water. If you do choose to operate these toys in open water, enforcement officers will treat them as pleasure craft that are subject to the same strict rules.

Operating a remote-controlled vessel and a propeller-driven surfboard is against the law in Canada.

Minimum Safety Equipment Requirements

The following list names the minimum safety equipment required on board a pleasure craft. You may want to bring more equipment based on your type of boat, your activity and the current and forecasted weather and water conditions. Once you know the equipment you must carry on board your boat, read the following sections so you can get specific information about each piece.

REMEMBER: If you want information on workboats or commercial vessels' (non-pleasure craft) mandatory equipment, visit [Transport Canada's website](#).

MINIMUM SAFETY EQUIPMENT REQUIREMENTS BY BOAT TYPE AND LENGTH

NOTE: See page 19 for notes.

BOAT TYPE AND LENGTH	PERSONAL LIFESAVING APPLIANCES	VISUAL SIGNALS	VESSEL SAFETY EQUIPMENT	NAVIGATION EQUIPMENT	FIRE FIGHTING EQUIPMENT
<ul style="list-style-type: none"> • Paddleboats • Watercycles • Sealed-Hull and Sit-on-Top Kayaks 	<ol style="list-style-type: none"> 1. One (1) lifejacket or PFD for each person on board* 2. One (1) reboarding device (See Note 1) 3. One (1) buoyant heaving line at least 15 m (49'3") long 	<p>If boat is over 6 m</p> <ol style="list-style-type: none"> 4. One (1) watertight flashlight 5. Six (6) flares of type A, B or C (See Note 2) 	<ol style="list-style-type: none"> 6. One (1) bailer OR One manual bilge pump (See Note 3) OR Bilge-pumping arrangements 	<ol style="list-style-type: none"> 7. One (1) sound-signalling device or appliance 8. Navigation lights (See Note 4) 9. One (1) magnetic compass (See Note 5) 10. One (1) radar reflector (See Note 6) 	None
<p>*If everyone on board is wearing a lifejacket or a PFD of appropriate size, you are only required to carry</p> <ul style="list-style-type: none"> • 1) a sound-signalling device; and • 2) a watertight flashlight if the boat is used after sunset or before sunrise or in periods of restricted visibility. 					
<ul style="list-style-type: none"> • Canoes • Kayaks • Rowboats • Rowing Shells • Other Human-Powered Boats 	<ol style="list-style-type: none"> 1. One (1) lifejacket or PFD for each person on board 2. One (1) reboarding device (See Note 1) 3. One (1) buoyant heaving line at least 15 m (49'3") long 	<p>If boat is over 6 m</p> <ol style="list-style-type: none"> 4. One (1) watertight flashlight 5. Six (6) flares of type A, B or C (See Note 2) 	<ol style="list-style-type: none"> 6. One (1) bailer OR One manual bilge pump (See Note 3) OR Bilge-pumping arrangements 	<ol style="list-style-type: none"> 7. One (1) sound-signalling device or appliance 8. Navigation lights (See Note 4) 9. One (1) magnetic compass (See Note 5) 10. One (1) radar reflector (See Note 6) 	None
<ul style="list-style-type: none"> • Sailboards • Kiteboards 	<ol style="list-style-type: none"> 1. One (1) lifejacket or PFD for each person on board* 2. One (1) reboarding device (See Note 1) 3. One (1) buoyant heaving line at least 15 m (49'3") long 	None	<ol style="list-style-type: none"> 5. One (1) manual propelling device OR One (1) anchor and at least 15 m (49'3") of cable, rope or chain in any combination 6. One (1) bailer or manual bilge pump (See Note 3) 	<ol style="list-style-type: none"> 7. One (1) sound-signalling device or appliance 8. Navigation lights (See Note 4) 9. One (1) magnetic compass (See Note 5) 10. One (1) radar reflector (See Note 6) 	None
<p>*If everyone on board is wearing a lifejacket or a PFD of appropriate size, you are only required to carry :</p> <ul style="list-style-type: none"> • 1) a sound-signalling device; and • 2) a watertight flashlight if the boat is used after sunset or before sunrise or in periods of restricted visibility. <p>NOTE: Kiteboarders and sailboarders should not wear a lifejacket or PFD that is fitted with an automatic inflator.</p>					

BOAT TYPE AND LENGTH	PERSONAL LIFESAVING APPLIANCES	VISUAL SIGNALS	VESSEL SAFETY EQUIPMENT	NAVIGATION EQUIPMENT	FIRE FIGHTING EQUIPMENT
<ul style="list-style-type: none"> Personal Watercraft (PWC) 	<ol style="list-style-type: none"> One (1) lifejacket or PFD for each person on board* One (1) reboarding device (See Note 1) One (1) buoyant heaving line at least 15 m (49'3") long 	<ol style="list-style-type: none"> One (1) watertight flashlight OR Three (3) flares of type A, B or C (See Note 2) 	<ol style="list-style-type: none"> One (1) manual propelling device OR One (1) anchor and at least 15 m (49'3") of cable, rope or chain in any combination One (1) bailer or manual bilge pump (See Note 3) 	<ol style="list-style-type: none"> One (1) sound-signalling device or appliance Navigation lights (See Note 4) One (1) magnetic compass (See Note 5) One (1) radar reflector (See Note 6) 	<ol style="list-style-type: none"> One (1) 5BC fire extinguisher
<p>*If every person on board a personal watercraft is wearing a lifejacket or a PFD of an appropriate size, you are only required to carry:</p> <ul style="list-style-type: none"> 1) a sound-signalling device; 2) a watertight flashlight or three pyrotechnic distress signals other than smoke signals; 3) a magnetic compass if the personal watercraft is navigated out of sight of navigation marks; and 4) navigation lights if the personal watercraft is used after sunset or before sunrise or in periods of restricted visibility. <p>NOTE: Lifejacket or PFD must be inherently buoyant.</p>					
<ul style="list-style-type: none"> Sail and Power Boats up to 6 m (19'8") 	<ol style="list-style-type: none"> One (1) lifejacket or PFD for each person on board One (1) reboarding device (See Note 1) One (1) buoyant heaving line at least 15 m (49'3") long 	<p>If boat is equipped with a motor</p> <ol style="list-style-type: none"> One (1) watertight flashlight OR Three (3) flares of type A, B or C (See Note 2) 	<ol style="list-style-type: none"> One (1) manual propelling device OR One (1) anchor and at least 15 m (49'3") of cable, rope or chain in any combination One (1) bailer or manual bilge pump (See Note 3) 	<ol style="list-style-type: none"> One (1) sound-signalling device or appliance Navigation lights (See Note 4) One (1) magnetic compass (See Note 5) One (1) radar reflector (See Note 6) 	<ol style="list-style-type: none"> One (1) 5BC fire extinguisher if equipped with an inboard engine, a fixed fuel tank of any size, or a fuel-burning cooking, heating or refrigerating appliance
<ul style="list-style-type: none"> Sail and Power Boats over 6 m and up to 9 m (19'8" - 29'6") 	<ol style="list-style-type: none"> One (1) lifejacket or PFD for each person on board One (1) reboarding device (See Note 1) One (1) buoyant heaving line at least 15 m (49'3") long OR One (1) lifebuoy attached to a buoyant line at least 15 m (49'3") long 	<ol style="list-style-type: none"> One (1) watertight flashlight Six (6) flares of type A, B or C (See Note 2) 	<ol style="list-style-type: none"> One (1) manual propelling device OR One (1) anchor and at least 15 m (49'3") of cable, rope or chain in any combination One (1) bailer or manual bilge pump (See Note 3) 	<ol style="list-style-type: none"> One (1) sound-signalling device or appliance Navigation lights (See Note 4) One (1) magnetic compass (See Note 5) One (1) radar reflector (See Note 6) 	<ol style="list-style-type: none"> One (1) 5BC fire extinguisher if equipped with a motor One (1) 5BC fire extinguisher if equipped with a fuel-burning cooking, heating or refrigerating appliance

BOAT TYPE AND LENGTH	PERSONAL LIFESAVING APPLIANCES	VISUAL SIGNALS	VESSEL SAFETY EQUIPMENT	NAVIGATION EQUIPMENT	FIRE FIGHTING EQUIPMENT
<ul style="list-style-type: none"> Sail and Power Boats over 9 m and up to 12 m (29'6" – 39'4") 	<ol style="list-style-type: none"> One (1) lifejacket or PFD for each person on board One (1) reboarding device (See Note 1) One (1) buoyant heaving line at least 15 m (49'3") long One (1) lifebuoy attached to a buoyant line at least 15 m (49'3") long 	<ol style="list-style-type: none"> One (1) watertight flashlight Twelve (12) flares of type A, B, C or D, not more than six (6) of which are of type D (See Note 2) 	<ol style="list-style-type: none"> One (1) anchor and at least 30 m (98'5") of cable, rope or chain in any combination One (1) manual bilge pump (See Note 3) OR Bilge-pumping arrangements 	<ol style="list-style-type: none"> One (1) sound-signalling device or appliance Navigation lights (See Note 4) One (1) magnetic compass (See Note 5) One (1) radar reflector (See Note 6) 	<ol style="list-style-type: none"> One (1) 10BC fire extinguisher if equipped with a motor One (1) 10BC fire extinguisher if equipped with a fuel-burning cooking, heating or refrigerating appliance
<ul style="list-style-type: none"> Sail and Power Boats over 12 m and up to 24 m (39'4" – 78'9") 	<ol style="list-style-type: none"> One (1) lifejacket or PFD for each person on board One (1) reboarding device (See Note 1) One (1) buoyant heaving line at least 15 m (49'3") long One (1) lifebuoy equipped with a self-igniting light or attached to a buoyant line at least 15 m (49'3") long 	<ol style="list-style-type: none"> One (1) watertight flashlight Twelve (12) flares of type A, B, C or D, not more than six (6) of which are of type D (See Note 2) 	<ol style="list-style-type: none"> One (1) anchor and at least 50 m (164'1") of cable, rope or chain in any combination Bilge-pumping arrangements 	<ol style="list-style-type: none"> One (1) sound-signalling appliance. Two required if the boat is 20 m and over that meets the applicable standards set out in the <i>Collision Regulations</i> Navigation lights (See Note 4) One (1) magnetic compass that meets the requirements set out in the <i>Navigation Safety Regulations</i> (See Note 5) One (1) radar reflector (See Note 6) 	<ol style="list-style-type: none"> One (1) 10BC fire extinguisher at all of the following locations: <ul style="list-style-type: none"> at each access to any space where a fuel-burning cooking, heating or refrigerating appliance is fitted; at the entrance to any accommodation space; and at the entrance to the machinery space. One (1) axe Two (2) buckets of at least 10 L each
<ul style="list-style-type: none"> Sail and Power Boats over 24 m (78'9") 	<ol style="list-style-type: none"> One (1) lifejacket or PFD for each person on board One (1) reboarding device (See Note 1) One (1) buoyant heaving line at least 30 m (98'5") long Two (2) SOLAS lifebuoys, of which: <ul style="list-style-type: none"> one (1) is attached to a buoyant line at least 30 m (98'5") long; and one (1) is equipped with a self-igniting light. Lifting harness with appropriate rigging 	<ol style="list-style-type: none"> One (1) watertight flashlight Twelve (12) flares of type A, B, C or D, not more than six (6) of which are of type D (See Note 2) 	<ol style="list-style-type: none"> One (1) anchor and at least 50 m (164'1") of cable, rope or chain in any combination Bilge-pumping arrangements 	<ol style="list-style-type: none"> Two (2) sound-signalling appliances that meets the applicable standards set out in the <i>Collision Regulations</i> Navigation lights (See Note 4) One (1) magnetic compass that meets the requirements set out in the <i>Navigation Safety Regulations</i> (See Note 5) One (1) radar reflector (See Note 6) 	<ol style="list-style-type: none"> One (1) 10BC fire extinguisher at all of the following locations: <ul style="list-style-type: none"> at each access to any space where a fuel-burning cooking, heating or refrigerating appliance is fitted; at the entrance to any accommodation space; and at the entrance to the machinery space. One (1) power-driven fire pump located outside the machinery space, with one fire hose and nozzle that can direct water into any part of the boat Two (2) axes Four (4) buckets of at least 10 L each

Note 1 – Reboarding Device

A reboarding device is only required if the vertical height that a person must climb to reboard the boat from the water (freeboard) is over 0.5 m (1'8").

Note 2 – Flares

Flares are not required for a boat that:

- is operating on a river, canal or lake in which it can never be more than one (1) nautical mile (1.852 km) from shore; or
- has no sleeping quarters and is engaged in an official competition or in final preparation for an official competition.

Note 3 – Bailer and Manual Bilge Pump

A bailer or manual bilge pump is not required for a boat that cannot hold enough water to make it capsize or a boat that has watertight compartments that are sealed and not readily accessible.

Note 4 – Navigation Lights

Navigation lights are only required if you operate the boat after sunset, before sunrise or in periods of restricted visibility (fog, falling snow, etc.).

Note 5 – Magnetic Compass



A magnetic compass is not required if the boat is 8 m (26'3") or less and you operate it within sight of navigation marks.

Note 6 – Radar Reflector

Radar reflectors are required for boats under 20 m (65'7") and boats built of mostly non-metallic materials. A radar reflector is not required if:

- the boat is used in limited traffic conditions, daylight and favourable environmental conditions, and where having a radar reflector is not essential to the boat's safety; or
- the small size of the boat or its operation away from radar navigation makes it impossible to install or use a radar reflector.

REMEMBER: Boating laws change from time to time, so make sure you have the most current information. If the *SAFE BOATING GUIDE* differs from the regulations, remember that it is always the current regulatory text that applies. To learn more about regulations, use the direct links in the CONTACT INFORMATION AND REFERENCES section of this guide.

Alternative Requirements for Boats Involved in Competition

Do you use your boat for racing?

If yes, you **may** be allowed to carry alternative safety equipment during:

- formal training;
- an official competition; or
- final preparations for an official competition.

USEFUL DEFINITIONS

Formal training

Practice for an official competition under the supervision of a coach or official certified by a governing body.

Official competition

Competition or regatta organized by a governing body or by a club or an organization that is affiliated with a governing body.

Final preparation for an official competition

Activities scheduled by the event organizer to prepare for the competitions at the competition venue.

Governing body

National water sport governing body that publishes rules and criteria related to the conduct and safety requirements for skill demonstrations, formal training or official competitions and that:

- certifies coaches and coaching programs;
- certifies officials and programs for officials; or
- recommends training and safety guidelines for certified coaches or officials.

Safety craft

Vessel, aircraft or other means of transport with a crew on board for watch and rescue activities during formal training, final preparation or official competitions.

Racing canoes, racing kayaks and rowing shells involved in competition

Racing canoes, racing kayaks and rowing shells do not have to carry the equipment listed in this guide if they (and their crews) are in formal training, in an official competition or in final preparation for an official competition and:

- are attended by a safety craft that, in addition to its own safety equipment, carries a lifejacket or PFD that fits, for each crew member of the racing boat with the biggest crew;
- OR
- if they carry:
 - a lifejacket or PFD that fits, for each crew member;
 - a sound-signalling device; and
 - a watertight flashlight if operated after sunset, before sunrise or in periods of restricted visibility.

In addition to the alternatives outlined above, **rowing shells** do not have to carry the equipment listed in this guide if they are competing in an official provincial, national or international regatta or competition, or are engaged in training at the event's venue.

Racing pleasure craft (other than canoes, kayaks and rowing shells) involved in competition

Racing-type boats do not have to carry the equipment listed in this guide if they:

- are engaged in formal training, in an official competition or in final preparation for an official competition;
- are operated under conditions of clear visibility;
- are attended by a safety craft; and
- carry the safety equipment required by the rules of their sport's governing body.

Sailboards or kiteboards involved in competition

Sailboards or kiteboards do not have to carry the equipment listed in this guide if they are engaged in an official competition where an attending safety craft carries lifejackets or PFDs that fit the sail/kite boarders and that can be put on in the water (It is not recommended that lifejackets or PFDs be fitted with an automatic inflator).

Safety Equipment Specifications

Personal Lifesaving Appliances



About 90% of people who drown in recreational boating incidents are not wearing a lifejacket or PFD. Even if you have one on board, conditions like rough winds, waves and cold water can make it very hard, if not impossible, to find it and put it on. Worse yet, if you unexpectedly fall into the water, the boat (with your lifejacket or PFD on board) could be too far away to reach.

If you remember one thing from this guide, it should be to always wear your lifejacket or PFD when on or near the water. It could save your life.

REMEMBER: Lifesaving cushions are not approved safety equipment on any boat.

To find a list of all Canadian-approved lifejackets and PFDs, check out the [Approved Products Catalogue Index](#). Lifejackets and PFDs are not the same! Note the differences and choose the right one.

A lifejacket or a PFD is the best insurance you can have on or near the water. Find one that suits your needs and wear it! Also, remember that you are required to carry a PFD or lifejacket of appropriate size for each person on board.

Lifejackets

Lifejackets come in red, orange or yellow. This makes you much easier to see in the water. Compared to PFDs, they offer a higher level of protection. There are three Canadian-approved lifejacket types to choose from:

	SOLAS (SAFETY OF LIFE AT SEA) LIFEJACKETS	STANDARD TYPE LIFEJACKETS	SMALL VESSEL LIFEJACKETS
PERFORMANCE IN THE WATER	Best performance: This lifejacket will turn you on your back in seconds to keep your face out of the water, even if you are unconscious.	Slower performance: This lifejacket will turn you on your back to keep your face out of the water, even if you are unconscious.	Slowest performance: This lifejacket will turn you on your back to keep your face out of the water, even if you are unconscious, but may do so more slowly.
SIZES AVAILABLE (BY BODY WEIGHT)	- Available in 2 sizes: <ul style="list-style-type: none"> Over 32 kg (70 lbs) Less than 32 kg (70 lbs) 	- Available in 2 sizes: <ul style="list-style-type: none"> Over 40 kg (88 lbs) Less than 40 kg (88 lbs) 	- Available in 3 sizes <ul style="list-style-type: none"> Over 41 kg (90 lbs) 18 kg (40 lbs) to 41 kg (90 lbs) Less than 18 kg (40 lbs)
MODELS AVAILABLE	- Keyhole	- Keyhole	- Keyhole - Vest

Lifejackets, including inflatables, that meet the new lifejacket standard adopted in 2007 offer more comfort and better performance.

Personal Flotation Devices (PFDs)

You can buy PFDs in a wide range of Canadian-approved types, sizes and colours. They do not offer the same level of protection as lifejackets for staying afloat and rolling you over on your back so you can breathe. However, since they are designed for constant wear, they are more comfortable than lifejackets.

Choose a PFD based on your needs and activity. If you plan to operate at high speeds, look for a PFD with three or more chest belts for security. If you will be boating in cold water (water less than 15°C), choose a PFD with some thermal protection. A large selection is also available for activities such as sailboarding, paddling, fishing and hunting. No matter what type of PFD you choose, you should choose a colour that makes you easy to see in the water. You should also consider attaching a non-metallic pealess whistle to the PFD.

Inflatable PFDs

You can also buy inflatable PFDs. Understand how to use and care for them properly. Note which activities and conditions they are approved for.

REMEMBER: You have to be wearing an inflatable PFD for it to be approved on an open boat. If the boat is not open then you only need to wear it while you are on deck or in the cockpit.

Restrictions for inflatable PFDs:

- You must be at least 16 years old to wear an inflatable PFD.
- No one may wear an inflatable PFD on a personal watercraft.
- No one may use an inflatable PFD for white-water paddling activities.

Although these PFDs inflate quickly, weak swimmers may feel it takes forever. All Canadian-approved inflatable PFDs have an oral inflation tube in case the CO₂ inflation system fails. Be aware that this tube could be hard to use when you are trying to keep your head above water.

Inflatable PFDs come in two styles:

- **vest types** that you can inflate orally, manually by pulling a toggle to activate a CO₂ inflation system or automatically by hydrostatic pressure valve released; and



- **pouch types** that you can inflate orally or manually by pulling a toggle to activate a CO₂ inflation system.



Test Your Lifejacket or PFD

Before you buy a lifejacket or PFD, read the approval label that comes with the device: it will provide valuable information about size, weight and approval. Then, try it on and make sure it fits comfortably:

- fasten all straps, zippers and ties and raise your arms over your head to see if it stays in place;
- ask someone to lift your lifejacket or PFD straight up at the shoulders. If it fits properly, the jacket will stay in place. If the zipper touches your nose or the jacket almost comes off, it is too loose.

An emergency is no time to try out a new device. It is a good idea to wear the lifejacket or PFD in a swimming pool or in shallow water, under supervision, to see how you float. Relax your body and let your head fall back. With a little help, your face should remain above water so you can breathe easily. If this is not the case, you may need a different size or a model that will provide more buoyancy.

Inflatable PFDs come with an owner's manual. Read it carefully. Try the PFD under supervision and before heading out to make sure you know how to use it.

To learn more about choosing a lifejacket or PFD, visit www.wearalifejacket.com.

Keep Kids Afloat



Make sure that you buy your child a Canadian-approved lifejacket or PFD. Also, look for these safety features:

- a large collar for head support;
- waist ties or elastic gathers in front and back;
- a safety strap that goes between the legs to prevent it from slipping over your child's head;
- buckles on the safety straps; and
- reflective tape.

Have your child try it on. It should fit snugly and not ride up over the chin or ears. If there are more than 7.6 cm (3") between your child's shoulders and the device, it is too big and could do more harm than good.

REMEMBER: There are no approved lifejackets or PFDs for infants under 9 kg (20 lbs). Learn more about finding the right lifejacket or PFD for your child [on our website](#).

Children should always wear a lifejacket or PFD and be within your reach. Set a good example and wear yours every time you are on the water.

Check the Labels



To be Canadian-approved, a lifejacket or PFD must have a label that states it has been approved by:

- Transport Canada;
- Canadian Coast Guard;
- Fisheries and Oceans Canada; or
- any combination of the above.

Lifejackets or PFDs approved by the U.S. Coast Guard are not Canadian-approved. However, visitors to Canada may bring their own lifejacket to use on a pleasure craft as long as it fits and it conforms to the laws of their home country.

Care for Your Lifejacket and PFD

Lifejackets or PFDs that are ripped or in poor condition are not considered approved. So take good care of yours! Follow these tips to keep yours in good condition:

- Regularly check its buoyancy in a pool or by wading out to waist-deep water and bending your knees to see how well you float.
- Make sure that straps, buckles and zippers are clean and work well.
- Tug on straps to make sure they are well attached and there is no sign of wear.
- Dry the lifejacket or PFD in open air and avoid direct heat sources, such as direct sunlight.

- Store it in a dry, well-ventilated place where it is easy to reach.
- Do not dry clean your lifejacket or PFD. Wash it with mild soap and running water.
- Never sit or kneel on your lifejacket or PFD or use it as a fender for your boat.

Buoyant Heaving Lines



A buoyant heaving line is approved for use as long as it:

- floats;
- is in good condition;
- is made of one full length of rope, not many shorter ropes tied together;
- is long enough for the boat you will be using; and
- is used only as safety equipment so that it is easy to find and use in an emergency.

Lifebuoys



When buying a lifebuoy, look for a Transport Canada approval stamp or label. Lifebuoys must be at least 610 mm (24") in diameter. **Smaller lifebuoys and horseshoe-type devices are not approved.**

Reboarding Devices



A reboarding device allows someone to get back on the boat from the water. A transom ladder or swim platform ladder meets this requirement.

Visual Signals

Watertight Flashlights



Make sure that the batteries in your watertight flashlight are still good before every trip. If you lose power, a watertight flashlight may be your only way to signal for help.

Distress Flares

When buying distress flares, look for a Transport Canada approval stamp or label. Remember that flares are only good for four years from the date of manufacture, which is stamped on every flare. Ask the retailer how to safely dispose of your outdated flares.

Store your flares within reach and vertically in a cool, dry location (such as a watertight container) to keep them in good working condition. Always follow the manufacturer's recommendations for safe storage.

Tips on Using Flares

You may use flares only in an emergency when you believe there is a chance of it being seen.

Fire aerial flares at an angle into the wind. In strong wind, lower the angle to 45 degrees, at most. Always read the manufacturer's instructions before you use flares.

There are four types of approved flares: A, B, C and D.

Type A - Rocket Parachute Flare



- creates a single red star;
- reaches a height of 300 m (984') and comes down slowly with a parachute;
- is easily seen from the ground or air; and
- burns for at least 40 seconds.

Type B - Multi-Star Flare



- creates two or more red stars;
- reaches a height of 100 m (328'1");
- is easily seen from the ground or air;
- each burns for four or five seconds.

REMEMBER: Some multi-star flares (type B) project only one star at a time. When using the single star type, you must fire two flares within 15 seconds of each other. This means that you will need to double the number of cartridges to meet the requirements.

Type C - Hand Flare



- is a red flame torch that you hold in your hand;
- provides limited visibility from the ground;
- is best used to help air searchers locate you; and
- burns for at least one minute.

When lighting the flare, hold it clear of the boat and downwind. Do not look directly at the flare while it is burning.

Type D - Smoke Signal (Buoyant or Hand-Held)



- creates a dense orange smoke for:
 - three minutes (buoyant);
 - 50 seconds (hand);
- is to be used only in daylight.

Position your smoke signal downwind and follow the directions carefully.

Vessel Safety Equipment

Manual Propelling Devices



A manual propelling device can be:

- a set of oars;
- a paddle; or
- anything you can operate by hand or foot to propel a boat, including the rudder on a small open sail boat or a paddle wheel on a paddleboat.

Anchors



Having the right anchor and cable (refer to **SAFETY EQUIPMENT REQUIREMENTS** section) for your boat is important. If you do not, rough winds and water can cause it to drag, leaving your boat to drift. This is especially dangerous if you are asleep or swimming nearby. Make sure your boat is well anchored and keep watch to detect signs of dragging.

Bailers and Manual Bilge Pumps



Bailers must have these characteristics:

- hold at least 750 ml (3 cups);
- have an opening of 9 cm (3.5") diameter or more; and
- be made of plastic or metal.

Did you know that you can make a bailer out of a four-litre rigid plastic bottle (useful for small open boats)? This is an inexpensive way to meet the requirements and have an efficient bailer on board.

Follow these steps:

- rinse the bottle thoroughly;
- secure the lid;
- cut off the bottom; and
- cut along the side with the handle.

If you have a **manual bilge pump**, the pump and hose must be long enough to:

- reach the bilge; and
- discharge water over the side of the boat.



Navigation Equipment

Sound-Signalling Devices



Boats under 12 m (39'4") without a fitted sound-signalling appliance must carry a sound-signalling device.

This can be:

- a pealess whistle;
- a compressed gas horn; or
- an electric horn.

Sound-Signalling Appliances



All boats 12 m (39'4") or more must have a fitted whistle. Boats over 20 m (65'7") must also have a bell. Check Annex III of the *Collision Regulations* for the technical standards these appliances must meet.

Navigation Lights



Navigation lights help prevent collisions by making your vessel and its direction of travel more visible to others. Vessels near you will make decisions based on the information your lights provide. The navigation lights on other vessels can help you tell the direction they are moving or whether they are at anchor or engaged in some other activity.

USEFUL DEFINITIONS

Masthead light

A white light placed over the fore and aft centreline of the vessel showing an unbroken white light over an arc of the horizon of 225 degrees. It must be fixed so the light can be seen from right ahead to 22.5 degrees abaft the beam on both sides of the vessel.

Sidelights

A green light on the starboard side (right) and a red light on the port side (left), each showing an unbroken light over an arc of the horizon of 112.5 degrees. Both lights must be fixed so they can be seen from right ahead to 22.5 degrees abaft the beam on its respective side.

In a vessel of less than 20 m (65'7") in length, the sidelights may be combined in one lantern carried on the fore and aft centreline of the vessel.

Sternlight

A white light placed as nearly as possible at the stern (back) of the boat, showing an unbroken light over an arc of the horizon of 135 degrees and fixed so the light can be seen 67.5 degrees from right aft on each side of the vessel.

All-round light

A light showing an unbroken light over an arc of the horizon of 360 degrees. .

If your boat is equipped with navigation lights, they must work and meet the technical standards set out in the *Collision Regulations*. For example, you must:

- show navigation lights if the boat is operated after sunset or before sunrise and during periods of reduced visibility;
- make sure your vessel is equipped with the proper lights for its size and purpose; and
- verify that the lights are correctly mounted.





The following table lays out some basic requirements and options for navigation lights and shapes, based on the type and length of your boat. **If you have a sail boat that is also equipped with a motor, you must meet the standards for both sail boats and power boats.**

REMEMBER: A sailboat when also being propelled by a motor shall exhibit forward where it can best be seen a conical shape, point downwards.

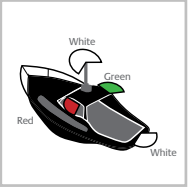
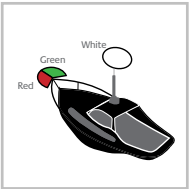
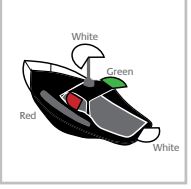

Read the *Collision Regulations* (referred to in each of the following categories) for more details. **If you are fitting your own navigation lights,** refer to the positioning requirements in the *Collision Regulations* (ANNEX I: Positioning and Technical Details of Lights and Shapes).

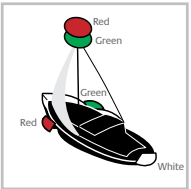
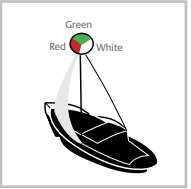
NAVIGATION LIGHT AND SHAPE REQUIREMENTS BY BOAT TYPE AND LENGTH

BOAT TYPE AND LENGTH	REQUIREMENTS			
<ul style="list-style-type: none"> Power Boats under 12 m (39'4") - Rule 23 	<p>Option 1</p> <ul style="list-style-type: none"> -One (1) masthead light; -Sidelights; and -One (1) sternlight <p>OPTIONAL - A second masthead abaft of and higher than the forward one light</p>		<p>Option 2</p> <ul style="list-style-type: none"> -One (1) all-round white light; and -Sidelights 	
<ul style="list-style-type: none"> Power Boats from 12 m (39'4") to under 50 m (164'1") - Rule 23 	<ul style="list-style-type: none"> -One (1) masthead light; -Sidelights; and -One (1) sternlight <p>OPTIONAL - A second masthead light abaft of and higher than the light mounted forward</p>			
<ul style="list-style-type: none"> Sail Boats under 7 m (23') - Rule 25 <p>NOTE : In the Canadian waters of a roadstead (mooring area), harbour, river, lake or inland waterway, a sail boat under 7 m that is also being propelled by a motor is not required to exhibit forward a conical shape (point downwards) where it can best be seen.</p>	<p>Option 1</p> <ul style="list-style-type: none"> -Sidelights; and -One (1) sternlight 		<p>Option 2</p> <ul style="list-style-type: none"> -Sidelights; -One (1) sternlight; and -Two (2) all-round lights in a vertical line, the upper being red and the lower green 	
<p>Option 3</p> <ul style="list-style-type: none"> -One (1) lantern, combining the sidelights and sternlight above 			<p>Option 4</p> <p><i>(if other options are not practicable)</i></p> <ul style="list-style-type: none"> -An electric torch or lighted lantern showing a white light (a watertight flashlight is acceptable) that you must use far enough in advance to prevent a collision 	

BOAT TYPE AND LENGTH	REQUIREMENTS	
<ul style="list-style-type: none"> Sail Boats from 7m (23') to under 20m (65'7") - Rule 25 <p>NOTE: In the Canadian waters of a roadstead (mooring area), harbour, river, lake or inland waterway, a sail boat under 12 m that is also being propelled by a motor is not required to exhibit forward a conical shape (point downwards) where it can best be seen.</p>	<p>Option 1</p> <ul style="list-style-type: none"> -Sidelights; and -One (1) sternlight 	<p>Option 2</p> <ul style="list-style-type: none"> -Sidelights; -One (1) sternlight; and -Two (2) all-round lights in a vertical line, the upper being red and the lower green
	<p>Option 3</p> <ul style="list-style-type: none"> -One (1) lantern, combining the sidelights and sternlight above 	
<ul style="list-style-type: none"> Sail Boats 20 m (65'7") and over - Rule 25 	<p>Option 1</p> <ul style="list-style-type: none"> -Sidelights; and -One (1) sternlight 	<p>Option 2</p> <ul style="list-style-type: none"> -Sidelights; -One (1) sternlight; and -Two (2) all-round lights in a vertical line, the upper being red and the lower green
<ul style="list-style-type: none"> Human-Powered Boats - Rule 25 	<p>Option 1</p> <ul style="list-style-type: none"> -An electric torch or lighted lantern showing a white light (a watertight flashlight is acceptable) ready to use far enough in advance to prevent a collision 	<p>Option 2</p> <ul style="list-style-type: none"> -Same lights as listed for sail boats, according to length
<ul style="list-style-type: none"> Boats at Anchor under 50 m (164'1") - Rule 30 <p>NOTE: Boats under 7 m are not required to show prescribed lights and marks, except in or near a narrow channel, fairway or anchorage, or where other vessels normally navigate.</p>	<p>Option 1</p> <ul style="list-style-type: none"> -One (1) all-round white light. <p>OPTIONAL - Another all-round white light at or near the stern and at a lower level than the other light</p> <p>NOTE: You may use any available lights to illuminate decks</p>	<p>Option 2 (during the day)</p> <ul style="list-style-type: none"> -One (1) ball

Radar Reflectors



Reflectors help larger vessels to see small boats on their radar screens, and may be the only way that they will be able to spot you.

A radar reflector can enhance your safety on the water, but only if it is big enough and well placed on your boat. When buying a reflector, there is no substitute for size – so buy the biggest one that will fit your boat. There are all kinds of reflectors of varying quality on the market, so make sure you look carefully before buying. Keep in mind that placement height is also very important.

Reflectors should be located

- above all superstructures; and
- at least 4 m (13'1") above the water, if possible.

Fire Fighting Equipment

Portable Fire Extinguishers



Do you know that different types of fires require different types of extinguishers?

The letters on a fire extinguisher tell you what types of fires it is designed to fight. Fires are classified as follows:

- **Class A:** Materials that burn, such as wood, cloth, paper, rubber and plastic
- **Class B:** Liquids that burn, such as gas, oil and grease
- **Class C:** Electrical equipment

You should buy a fire extinguisher with an ABC rating. The number before the letters on the extinguisher tells you how big a fire it will put out compared to other extinguishers. For example, a 10BC device will put out a larger fire than a 5BC device.

Check the Labels

The fire extinguisher you choose must bear a mark that shows it is certified by:

- Underwriters Laboratories of Canada (ULC);
- Underwriters' Laboratories Inc. (UL); or
- United States Coast Guard.

REMEMBER: You may no longer refill halon fire extinguishers.

Ensure Maintenance

Check your extinguishers often for correct operating pressure and make sure that you and your guests know how to use them. Have a qualified person maintain, service and recharge your extinguishers as per the manufacturer's instructions. Take dry chemical devices out of their bracket and give them a few hard shakes in the upside down position about once a month to keep the contents active.

Suggested Items

If you will be on the water for more than a few hours, you may want to have:

Spare clothing in a watertight bag



Weather conditions can change quickly, so be prepared.

Drinking water and snacks

Drinking water and snacks will help you avoid fatigue and dehydration.

Tool kit and spare parts

You may need to make repairs when you are out on the water. Take along a tool kit and spare parts like fuses, bulbs, a spare propeller, nuts and bolts, penetrating oil, duct tape and spark plugs. You should also have and know how to use the tools and materials you need to stop hull leaks until you get to shore. Bring the owner's manual and any other guidebook you might need on your trip.

First aid

When boating, you may end up far from medical help, so take a first aid kit with you. Store it in a dry place and replace used and outdated contents regularly. Pack it to meet your specific needs.

Do you know the symptoms of cold shock, hypothermia, heat exhaustion and allergic reactions? Do you know how to stop bleeding, perform CPR or treat shock? If not, take a first aid course as soon as possible. First aid knowledge can make the difference between permanent injury and full recovery, or even life and death. To learn more about first aid training, contact the nearest training provider.

Northern Lakes, MANITOBA



BEFORE YOU GO

This section will help you get your boat, your guests and yourself prepared before heading out on the water.

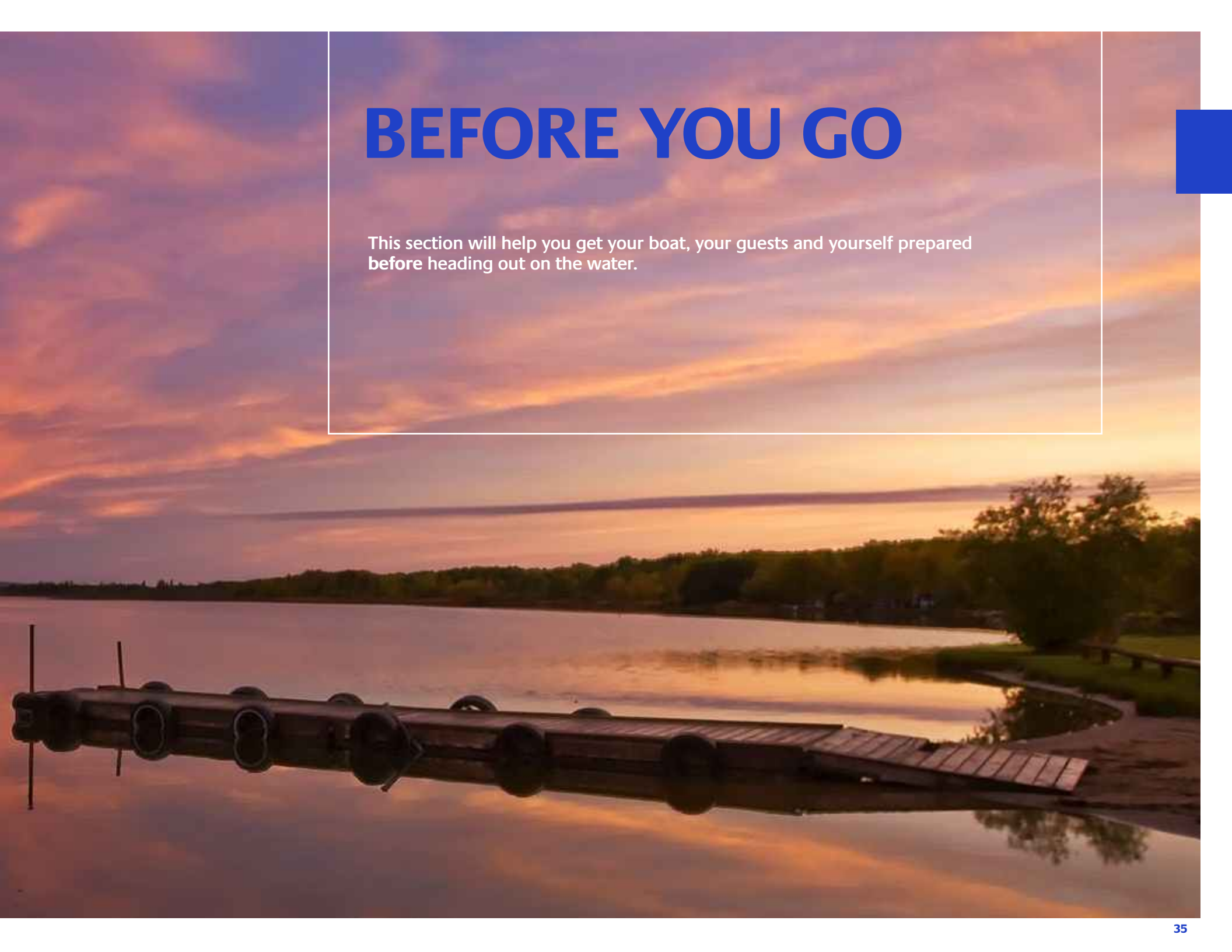

INSPECT YOUR BOAT

Take a few minutes to make sure you are ready to boat safely before you leave. This will reduce risk when you are out on the water. More than half of all calls for help are from boaters in trouble because of motor problems, including running out of fuel!

Operating a boat that you know is not seaworthy is against the law. You must keep your boat, its engine and all equipment in good working order. Whether you own, rent or borrow a boat, use the Pre-Departure Checklist (see **REFERENCE CARDS** section of this guide) to make sure you are ready before leaving.

Explain safe boating rules to everyone on board before heading out. Tell your guests where you keep the safety equipment and how to use it. Make sure that at least one other person on board knows how to operate the boat in case something happens to you.

MONITOR THE WEATHER

Weather and water conditions play a big role in your safety on the water. Before heading out, make sure you get the latest forecast for your area and that you understand what it means. You should also be aware of local factors (like topography) that may cause weather conditions to differ from the forecast. The best source for this information is people who know the area well.

Summer thunderstorms can strike quickly and without warning, so keep your eye on the sky when you are out on the water. If it starts to look dark and cloudy, and conditions are changing quickly, head for shore. Remember to check your up-to-date nautical charts in advance so that you will know where to find shelter.

Environment Canada issues marine forecasts several times a day in many ways. If you have a marine radio, you can get weather updates while you are on the water. These forecasts provide information on wind speed and direction, weather, visibility and freezing spray (if applicable). Some forecasts discuss current conditions while others discuss the conditions you can expect over several days. Marine forecasts are also available online.

When it expects high wind speeds, Environment Canada will issue a wind warning in the marine forecast:

- **Strong Wind Warning** (20 – 33 knots) (37 – 61 km/h)
 - **Gale Warning** (34 – 47 knots) (62 – 87 km/h)
 - **Storm Warning** (48 – 63 knots) (88 – 117 km/h)
 - **Hurricane Force Wind Warning** (64 knots or more) (118 km/h or more)
- Marine weather forecasts are available 24 hours a day in some areas through Environment Canada's Weatheradio service on the VHF-FM radio band. To get these forecasts, you need a Weatheradio receiver or a VHF marine radio. You can also get continuous forecasts from the Canadian Coast Guard on marine VHF weather channels.

Get a complete list of Environment Canada weather services across Canada online.

MAKE AND FILE A SAIL PLAN

A sail plan (also known as a trip or float plan) includes the route you plan to travel and describes your boat. No matter what you call them, you should file one before heading out — even if it is just for an hour or two (see **REFERENCE CARDS** section of this guide).

File your sail plan with someone you trust and tell them to contact a Rescue Coordination Centre if you are late. You will find their telephone numbers in the **CONTACT INFORMATION AND REFERENCES** section of this guide.

If you are taking a long trip, you should file a daily position report (especially if you change your planned route). Be sure to let people know when you return or safely arrive at your next stop. If you do not, people may worry and launch a search, which can waste Search and Rescue resources.

CARRY AND USE OFFICIAL NAUTICAL CHARTS AND PUBLICATIONS



An open body of water may seem inviting, but remember that there are no clearly marked traffic lanes on the water, which can make navigation difficult.

To help make navigation safer, the law requires you to carry the following for each area you plan to boat in:

- the latest edition of the largest scale chart (when available); and
- the latest edition of related documents and publications, including *Notices to Mariners*, *Sailing Directions*, tide and current tables, and the *List of Lights, Buoys and Fog Signals*.

The documents, charts and publications may not be necessary* if your boat is less than 100 tons and that you have sufficient knowledge of the waterways including:

- shipping routes;
- lights, buoys and marks;
- boating hazards; and
- boating conditions, such as tides, currents, ice and weather patterns.

*Safe and efficient navigation must not be compromised.

The Canadian Hydrographic Service (CHS) is the official source for navigational charts and publications in Canada's waters. Under the Charts and Nautical Publications Regulations made pursuant to the Canada Shipping Act, 2001, boaters must use charts issued officially or on the authority of the CHS. You can buy official paper and digital charts from authorized chart dealers. For more information or to find the nearest authorized chart dealer, visit www.charts.gc.ca.

Before heading out, you should know how to:

- plot a course;
- determine your position; and
- use:
 - a compass along with nautical charts;
 - electronic navigation equipment; and
 - references such as tide tables, Canada's buoyage system, navigation lights and signals, *Notices to Mariners* and *Sailing Directions*.

Avoid danger by steering clear of rapids and currents, and be sure not to obstruct commercial navigation in commercial shipping channels.

REMEMBER: Even though you use charts, keep proper watch at all times.

PLAN TO AVOID LOCAL HAZARDS



Being prepared means more than having your boat and equipment in good working order. You should also:

- Check nautical charts for overhead obstacles, bridges and underwater cables in your boating area.
- Read nautical charts with publications like *Sailing Directions*. Looking at tide tables and current atlases will also help you learn about water levels, times of low, slack and high tides, and the direction of water flow.
- Stay away from swimming areas – even canoes and kayaks can injure swimmers.
- Avoid boating too close to shore.
- Talk to local residents who know the waters if you are in an area that is not covered by marine charts. They may be able to point out low-head dams, rapids and white water, as well as describe local wind conditions, currents and areas of rapid high-wave build-up.

FUEL SAFELY

Leaking or spilled fuel not only harms the marine environment but presents a fire hazard. Follow these steps when fuelling — it is the safe thing to do and it is the law.

- Moor your boat securely to prevent spills.
- Shut off all engines.
- Send guests ashore.
- Put out all open flames.
- Do not smoke.
- Turn off electrical switches and power supplies.
- Do not use electrical devices such as portable radios.
- Close all windows, portholes, hatches and cabin doors.
- Remove portable tanks from the vessel before refuelling.
- Ground the nozzle against the filler pipe.
- Know how much fuel your tank can hold and do not overfill it — you have a duty to prevent fuel leaks and spills into your boat's hull and the water.
- Wipe up spills and dispose of the used cloth or towel in an approved container.
- Run the engine compartment blower for at least four minutes immediately before starting the gasoline engine.
- Check for vapours from the engine compartment before you start up the engine.

New environmental laws affecting diesel fuel mean frequent changes to the type of diesel available at the pump. Follow the safety instructions provided by fuel suppliers, as well as your boat's engine and system user manuals.

BE AWARE OF CARBON MONOXIDE DANGERS

Carbon monoxide (CO) is a **deadly gas** you cannot see, smell or taste. CO comes in through your lungs and cuts off the oxygen supply to your body, causing death in minutes. Be alert! Symptoms include headaches, nausea and fatigue – but you might think you are just seasick or have the flu.

CO can come from anything that burns a carbon-based fuel (gasoline, propane, charcoal, oil, etc.) such as engines, gas generators, cooking ranges, heaters, etc. CO acts a lot like air. It does not rise or fall, but spreads evenly throughout an enclosed space.

Here are some tips to help protect yourself and others from CO poisoning:

- Idle your engine only in well-ventilated areas. A tail wind can easily carry CO back on board.
- Heat the cabin in a well-ventilated area.
- Cook in a well-ventilated area.
- Make sure that cabin extensions and areas fitted with canvas tops are well ventilated.
- Use only fuel-burning engines or appliances that are certified or designed for marine use and make sure to use them in well-ventilated areas only.
- Use a marine-grade CO detector and check its batteries before every trip.
- Be aware that CO can build up when:
 - two vessels are tied to each other;
 - you are docked alongside a seawall;
 - exhaust gases enter the space between pontoons;
 - your load causes the bow to ride high; or
 - a fuel-burning appliance or engine is running while your vessel is not moving.

REMEMBER: Carbon monoxide (CO) is not just a risk to boaters. Swimmers too can be overcome by breathing CO and drown in just minutes! Areas of high risk are under swim platforms and between the pontoons of houseboats.

REDUCE THE RISKS OF EXPLOSION

Fuel-Burning Appliances

Typical ventilation system

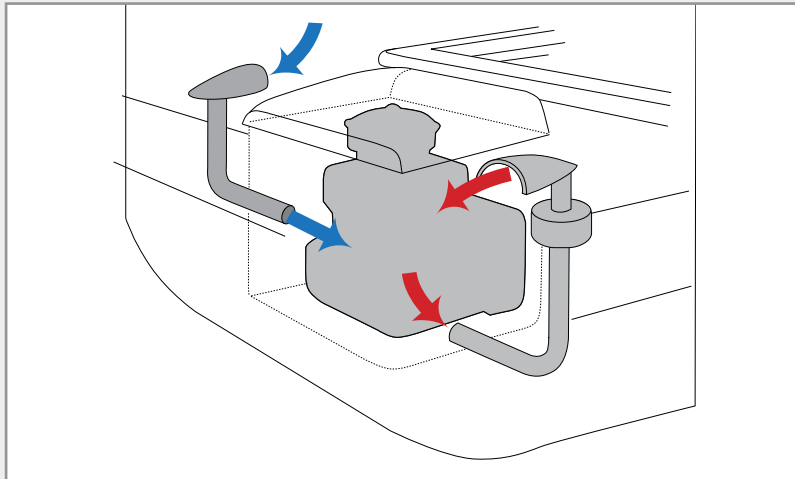

Typical propane installation with ventilation

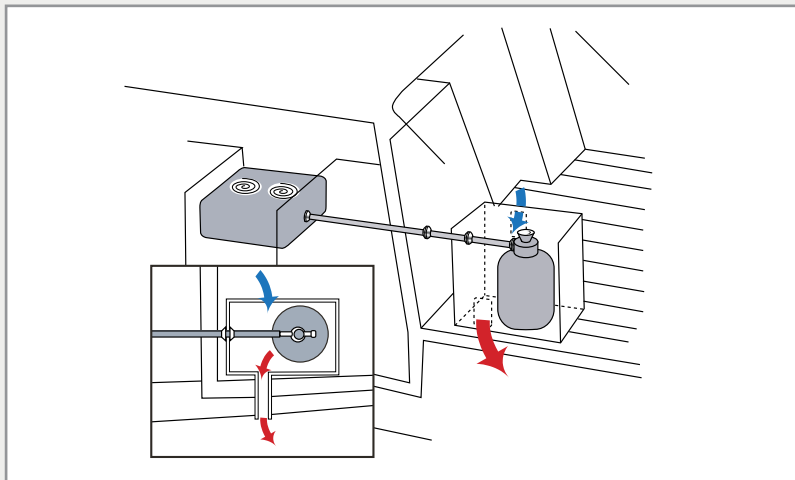

Gas vapours and leaking propane and butane are heavier than air and will quickly flow into the lower parts of your boat. They are very hard to remove and are **highly explosive**. On board appliances that run on propane or butane may present more risk than gasoline.

Here are some tips for using propane and butane safely:

- Use appliances and systems designed for marine use.
- Ask a qualified technician to install, maintain or repair your appliance/system according to the manufacturer's instructions and the marine standards.
- Use a fuel-burning appliance only in well-ventilated areas.
- Secure portable appliances and heaters so that unexpected movement does not cause a leak.
- Secure gas cylinders and tanks in an area with good ventilation.
- Always have someone paying attention to an open-flame heating, cooking or refrigeration system.

Ignition Protection

Every boat that has a gasoline engine or uses propane devices must have ignition-protected electrical devices. These parts are designed and made so that, under normal conditions, they will not ignite gasoline or propane fumes or vapour. This protection prevents sparks from escaping during use. Only use electrical components that are clearly labeled as ignition protected.

Many older boats, and even some new ones, have been fitted with converted car or truck engines. If you are not sure that your engine has ignition-protected parts in it, have a certified marine technician look at it and tell you if a replacement part (or related work done to the engine) has put the engine's ignition protection, and you, at risk.

LOAD YOUR BOAT PROPERLY



Overloading your boat with people, equipment or both is dangerous. Your boat's safety on the water depends on how much you put on the boat and where you put it. Too much weight will make your boat unstable and allow small waves to come on board. It will also reduce the amount your boat can roll before its sides dip under water. The greater the weight you carry on board, the more your boat is likely to roll, making it harder for it to return to normal.

As the boat operator, follow the recommended maximum safe limits on the Transport Canada compliance notice.

REMEMBER: These limits apply only in good weather and they assume that the weight is evenly distributed on board – so use your best judgment when conditions are less than perfect.

While the compliance notice of a boat over 6 m (19'8") will not have any recommended limits, the boat **can** become unstable, if you overload it. Refer to your boat's manufacturer for guidance and use good judgment when loading and operating your boat.

Other tips include:

- Evenly distribute the weight of occupants and equipment.
- Properly secure equipment to avoid shifting.
- Keep the load as low as possible.
- Be familiar with your craft's limitations and handling.
- Keep your centre of gravity as low as possible if you must move around.

HAVE A PLEASURE CRAFT COURTESY CHECK

Transport Canada works with boating safety organizations like the Canadian Power & Sail Squadrons (CPS) to offer free courtesy checks for pleasure craft. Check the [CPS website](#) to learn about the Recreational Vessel Courtesy Check Program.

If you request a check, a trained boating safety volunteer will board your boat, while alongside a dock or at a boat ramp, to:

- check out the safety equipment and other requirements;
- identify any problems; and
- discuss general boating safety issues.

Education and prevention are the keys to this program. Since program volunteers never issue any penalties, it is a great opportunity to learn more about boating safety and make sure that you are ready to head out on the water. The knowledge you gain from a courtesy check will help you to stay safe on the water year after year.

Note that the courtesy check is not a formal assessment of the condition of the vessel or any of the equipment. It is **your** responsibility to make sure that your vessel and related equipment meet all regulations that apply to your boat.



Lake Louise, ALBERTA



ON THE WATER

Everyone has the right to enjoy a safe, fun time on the water. This means that everyone also has a responsibility to respect and share waterways with wildlife, swimmers, divers, other boaters and watercraft ranging from sail boats to float planes. This section outlines some basic rules for Canada's waterways and guides you through some of the things you need to be aware of and watch out for while you are out on the water.

KNOW THE RULES OF THE ROAD AND SAFETY ON THE WATER

The “rules of the road” for Canada’s waterways help everyone avoid collisions on the water by setting out what every boater should do to avoid hitting or being hit by another vessel. This is not just a way to be polite – it is the law set out in the *Collision Regulations*, which apply to every vessel and operator on all navigable waterways – from canoes to supertankers.

Know the “rules of the road” and boat by them!

Avoid Close Quarters Situations

Keep Watch and Steer Clear of Shipping Lanes

Keep constant watch for others on the water. If you are sharing the water with large vessels, remember that it is harder for them to see you or change their route to avoid you. It also takes them longer to stop. These are all good reasons to be ready to move out of their way. Some boaters do not realize the risk they take when they cross shipping lanes or pass in front of larger vessels.

Here are some tips to remember since these vessels probably will not see you until it is too late.

- Always watch for others on the water and be ready to yield to large vessels in the safest way – keeping in mind the water and weather conditions. Use radar and radio if you have them.
- Navigate in groups of other small boats when possible, to be more visible.
- Stay off the water in fog or high winds.
- Stay clear of docked ferries, ferries in transit, vessels in tow and working fishing vessels.

Vessels less than 20 m (65’7”) and sailing vessels must stay out of the way of larger vessels that can safely navigate only within the navigation channel. A large vessel will remind you to give way by giving five or more short blasts of its horn. This means there is an emergency and you must get out of the way.

Give Plenty of Space to Tugs and Other Towing Vessels

Tugs may tow vessels on a long tow line that extends behind the tug. The tow line is often so long that it hangs below the surface of the water and is nearly invisible. Never pass between a tug and its tow. If a small boat were to hit the hidden line, it could capsize and be run down by the object being towed. Many towed objects will also have a long trailing line behind them. Give the tug and its tow plenty of space in every direction.

Learn How to Recognize a Towing Vessel at Night

Be alert for special lights displayed by tugs (or any vessels) towing barges, other boats or objects. The tug is usually more visible than its tow. In fact, the navigation lights of the tow may not include masthead lights and are often much dimmer than the tug lights.

If a power-driven vessel is towing another vessel or object from its stern, the power-driven vessel must display:

- sidelights;
- a sternlight;
- a towing light (yellow light with the same characteristics as the sternlight);
- two masthead lights in a vertical line – three if the tow exceeds 200 m (656’); and
- a diamond shape where it will be easy to see if the tow exceeds 200 m (656’).

The barge, vessel or any other object being towed must display:

- sidelights;
- a sternlight; and
- a diamond shape where it will be easy to see if the tow exceeds 200 m (656’).

If it is impractical for the vessel being towed to exhibit the lights stated above, it must have one all-around white light at each of the fore and aft ends.

Display the Right Lights When Towing Another Vessel

As a pleasure boater, you may need to tow another vessel in distress. Do everything you can to light the towing boat or object and the towing line. If you can't, find a way to indicate its presence and attract attention. If you are looking to fit your boat with navigation lights for towing, refer to Rule 24 of the *Collision Regulations* for details.

Avoid Dangerous Behaviours

Never try to spray swimmers, or cut in front of or try to jump the wake of other vessels. Some of the worst boating incidents happen when operators misjudge speed or distance.

Operate at a Safe Speed

Remember that you may have to stop or turn suddenly to avoid a collision, so operate at a safe speed. A safe speed depends on:

- your ability to see ahead – slow is the only safe speed in fog, mist, rain and darkness;
- current, wind, and water conditions;
- how quickly your boat can change direction;
- how many and what types of vessels are near you; and
- the presence of navigational hazards such as rocks and tree stumps.

Be very careful when boating where visibility is poor, such as entering or exiting a fog bank.

A boat's wake can damage other vessels, docks and the shoreline. It can also be a risk for swimmers, divers and people on small boats that might capsize. Be aware of how your boat's wake might affect others when choosing your speed. You will be responsible for any damages or harm you cause.

Never Cruise with Booze

Mixing alcohol and boating is far more dangerous than you may think. Under normal conditions, sun, wind, the motion of the boat and even just being tired can dull your senses. Alcohol makes things even worse, slowing your hand-eye coordination and clouding your judgment.

Never cruise with booze! You might harm yourself or others. You are responsible for the safety of your guests and for not putting other waterway users in danger. Always be prepared and alert. Wait until you are safely on shore before having a drink.

Remember that impaired driving (whether on land or water) is an infraction of the *Criminal Code of Canada*. The consequences, even for a first offence, can last a lifetime.

REMEMBER: Provinces and territories have their own rules on legal alcohol limits — when you can drink and how you may carry alcohol on board. Contact your local law enforcement authorities for more information.

Reduce Engine Noise

Every boat equipped with a motor other than a stock (unmodified) outboard engine must have a muffler and use it while operating within five nautical miles (9.26 km) of shore.

This does not apply to you if your boat was built before January 1, 1960, or if you are in an official competition or in formal training or final preparation for an official competition.

To learn more, see Section 1000 of the *Small Vessel Regulations*.

Be Aware of What is Going on Around You

As a boater, you must be aware of what is going on around you, both on the water and in the skies.

Divers Below the Surface

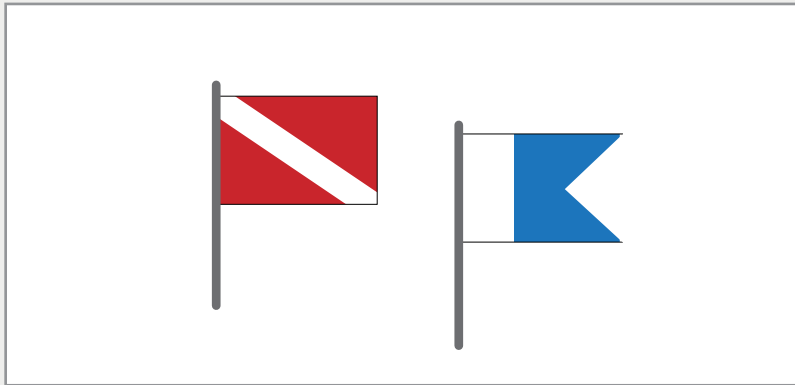

Diving is a popular water sport so know what a diver down flag looks like and keep careful watch for such flags. This is very important because the wake from your boat, along with weather and other factors, can make it hard to see divers' bubbles on the surface of the water.

Divers' boats must display the international blue and white Code Flag Alpha. A red and white flag on a buoy may also mark the area where diving is in progress, although divers may stray from the boundaries of the marked areas. If you decide to go diving from your boat, remember to display these flags as well. Best practice includes staying within 100 m (328') of your flag.

When you see either flag, give divers plenty of room by keeping your boat at least 100 m (328') from the flag. If you cannot stay that far away because of the size of the waterway, slow down as much as possible, move ahead with caution, and keep clear of the vessel and diving site.

Seaplanes



Watch for aircraft when you are out on the water and give plenty of space to any aircraft that is landing or taking off.

Safety Around Dams

Be very careful near canal dams and waste weirs where currents and undertows can be very hazardous.

Low-head dams are especially dangerous. Boaters and anglers often get too close to the downstream side of the dam, become drawn or sucked into the backwash current that takes them to the base of the dam, and are then forced under water and pushed away from the dam. After surfacing, the victim is drawn back in toward the base of the dam, starting the cycle over again.

Find out if there are any dams where you plan to go boating before you head out – and stay clear of them. When boating in an area with dams, be sure to follow the signage posted by dam authorities.

Safety Under Electric Lines

Contact with an aerial electric line or an electric arc zone (invisible) can kill you. That is why you should:

- Know the height of your boat above water (including gear installed on top of the mast).
- Know the minimal clearance identified on marine charts and avoid electric lines when this information is not available.
- Be careful at night: electric lines are more difficult to see.

Be Safe in Canals and Locks



Visiting Historic Canals and Locks

When visiting one of Canada's historic canals, make sure your boat has enough properly sized mooring lines and securely fastened floating fenders.

Many water activities are not allowed in a canal. Some rules include:

- no excessive noise between 11 p.m. and 6 a.m.;
- no fishing within 10 m (32'10") of a lock or approach wharf or from a bridge that passes over a navigation channel;
- no diving, jumping, scuba diving or swimming in a navigation channel or within 40 m (131') of a lock gate or a dam in a historic canal;
- no waterskiing or other towing activities while in a navigation channel or within 100 m (328'1") of a lock structure; and
- no mooring a vessel to a navigation aid.

Visit [Parks Canada](#) to learn more about historic canals and see [Historic Canal Regulations](#) for more information about the regulations that apply.

Passage through a Lock

Obey the posted speed limits and be aware of your boat's wake when approaching a lock. Other things to remember include:

- Keep clear of the channel near lock gates so that vessels can come and go.
- Look for the blue line on the mooring wharf that shows where to wait for the next lockage.
- Follow the instructions given by lockmasters and bridge operators (at a number of lock stations, a green traffic light is your signal to go ahead).
- Enter the lock slowly (no faster than 10 km/h) and have people at the bow and stern of your boat ready with mooring lines.
- If the lock has drop cables, loop boat lines around them, not to them, and only once your boat is safely positioned. If the lock has floating docks, lockmasters may tell you to tie up to one inside the lock chamber.
- Tend vessel lines carefully during the lockage. Looping a line around a deck cleat may provide extra leverage.
- Never leave bow or stern lines unattended.
- Switch off the engine(s) and generator. No open flames or smoking are allowed during lockage. The bilge blower must be operating during lockage.

When the lock gates open, wait for staff to direct you to restart your engine. Make sure you have brought all your mooring lines back into your boat and exit slowly and in order. Watch out for wind, currents and other vessels.

If you plan to use the St. Lawrence Seaway locks, consult the [Great Lakes St. Lawrence Seaway System](#) to learn how they operate.

Know What is Specific to Your Activity

Personal Watercraft (PWC)



Safe use of a personal watercraft (PWC) requires skill and experience. PWC operators must be at least 16 years old and have proof of competency and proof of age on board.

Before you let someone borrow your PWC, you must make sure that they know how to operate it safely and responsibly. Here are some other basic tips:

- Always wear a Canadian-approved lifejacket or PFD (inflatable PFDs are not allowed). Choose a bright color for better visibility.
- Wear thermal protection when operating in cold water (water less than 15°C).
- Read the owner's manual before setting out.
- Attach the engine shut-off line securely to your wrist or lifejacket or PFD.
- Respect speed limits and other vessel operation restrictions.
- Be cautious, courteous and respect your neighbours. Many people dislike the noise a PWC makes when it is operated for long periods of time at high speed in one place, especially when it is used to jump waves.
- Be aware of the impact your PWC can have on the environment. Avoid high speeds near shore.
- Stay alert! At high speeds, it is hard to see swimmers, water skiers, divers and other PWCs in time to avoid them.

- Do not operate your PWC after dark or when visibility is poor.
- Make sure your PWC is properly licensed and marked.
- Do not start your PWC if you smell gasoline or fumes in the engine compartment. Have a qualified technician check it.
- Replace the engine cover or seat before starting.



Waterskiing and Other Recreational Towing Activities

The rules that govern waterskiing also apply to other recreational towing activities like barefoot skiing, tubing, kneeboarding and parasailing. Here are rules to remember when towing someone with your boat:

- You must have a spotter on board the boat who can keep watch on each person you are towing and communicate with you.
- There must be an empty seat on your boat for each person you are towing in case they need to come on board.
- You may only tow persons with a personal watercraft made to carry three or more people.
- If someone you tow is not wearing a lifejacket or PFD, you must have one on board for him or her.
- You may not tow anyone when visibility is poor or from one hour after sunset to sunrise.
- No towing boat may be remotely controlled.

These requirements do not apply to a boat during formal training, in an official competition or in a skill demonstration if the boat meets the safety requirements of a governing body respecting such training, competitions or demonstrations.

Kayaking



Choose a bright colour such as red, yellow or orange for your lifejacket or PFD and kayak so that other boat operators can see you. Keep signalling devices within easy reach in case of emergency.

Sea kayakers should be aware of water temperatures, tides, currents, wind and maritime traffic.

Fishing and Hunting



Are you planning a trip across the lake to do some fishing or hunting? It takes more than steering your boat to get from point A to point B. You should:

- Always wear a Canadian-approved lifejacket or PFD. The brighter the colour the more visible you are to others.
- Have the minimum required equipment on board.
- Avoid overloading the boat. Overloading affects stability and causes the craft to be more difficult to handle.
- Know your craft's limitations and handling.
- Never cruise with booze.
- Learn about weather patterns, hypothermia and cold shock. One small mistake can put you in the water and your survival could depend on being prepared.
- Dress for boating.
- Make and file a sail plan. Have a way to contact your loved ones to let them know if your plans change.

HELP ENSURE SMALL VESSEL AND FACILITY SECURITY

Transport Canada believes the best way to keep small vessels and small vessel facilities safe and secure is to promote security awareness.

In Canada, small vessels including pleasure craft often operate near critical infrastructure such as hydro dams, power plants, chemical factories, bridges and key marine assets such as merchant vessels, ferries or cruise ships — potential targets for terrorist attacks.

A person or group could use a small vessel as:

- a floating bomb;
- a launch pad for attacking maritime industry or other critical infrastructure; or
- a means of smuggling weapons or terrorists.

Using small vessels for such activities could put our public safety and security, as well as our national commerce, trade and economy at risk. That is why you should know how to reduce the risk of terrorists using small vessels and know what to do if you see any suspicious activity on or near Canada's waterways. To learn more about security and terrorism in Canada, search the Internet for *Integrated Terrorism Assessment Centre*.

Maritime Security: A Global Concern

The International Maritime Organization (IMO) is the United Nations agency responsible for improving maritime safety and security. In 2008, it issued voluntary security guidelines for small vessels and facilities that Transport Canada helped to draft. They encourage you to report suspicious activities to appropriate authorities and describe best practices that we hope you will consider. The IMO voluntary guidelines will help you:

- plan for security incidents;
- offer security awareness programs; and
- prevent the theft or hijacking of, and unauthorized access to, small vessels.

Guidelines for Pleasure Craft

The following section is a summary of the IMO guideline's Appendix relating to pleasure craft.

REMEMBER: The overall safety and security of your boat, crew and passengers are your responsibility. That is why you should follow the advice below.

• Search Your Boat

Search your pleasure craft often to make sure that nothing suspicious has been placed on board, left behind or removed while the boat was unattended. If you find something suspicious, contact the appropriate local authorities right away. Do not handle suspicious packages or objects.

• Secure Your Vessel

Where possible, lock external doors, hatches and storage areas, and secure windows when you leave your pleasure craft. If you plan to leave it unattended for some time:

- moor the vessel according to local port by-laws;
- lock ignition switches to prevent theft/unauthorized use; and
- take the ignition key with you.

You may also choose to:

- install a small craft alarm system to alert you to any unauthorized movement (integrating the alarm system with smoke and fire sensors will give you a complete vessel protection system);
- using steer locks, if practical;
- etch the hull serial number onto windows and hatches; and
- install a hidden device to shut off the fuel line, or an engine immobilizer

• Protect Your Property

It is a good idea to mark and photograph your vessel and equipment. This will help authorities identify stolen equipment. Think about installing a radio frequency identification device (RFID) anti-theft system, if available. Why? Such systems reduce theft risk, increase recovery rates and in some instances, reduce insurance fees.

- **Choose a Safe Route**

Plan your route and ports of call carefully before a voyage. Make every effort to avoid areas where terrorism and criminal activities, including piracy and armed robbery, are a major threat. If you must travel through unsafe waters:

- travel with other vessels as quickly as possible;
- notify the local maritime authorities before you arrive or leave; and
- keep to a strict contact schedule, preferably via satellite, mobile telephone or similar system that terrorists cannot use to locate the vessel through radio direction finding.

- **Be Prepared**

Make sure your emergency plans include procedures for navigation problems, health and safety issues, and security alerts and incidents.

Conduct regular drills to make sure that everyone on board knows what to do if a safety or security incident occurs.

If you are navigating in high security-risk areas, **always** search your pleasure craft carefully before getting underway. Take extra care when searching places where a stowaway might hide, such as sail lockers. If possible, conduct the search with another person for your own safety. If you do find a stowaway, contact the appropriate authorities right away.

- **Report Security Incidents**

Have a plan for reporting and recording security incidents. The plan should include contacting the nearest police and/or coastal authorities, and nearby vessels.

To learn more about the IMO security guidelines, search the Internet for MSC.1/Circ.1283.

United States Small Vessel Strategy

If you navigate on waterways Canada shares with the United States, you may be interested in the Department of Homeland Security's Small Vessel Security Strategy, released in 2008. To learn more, search the Internet for *DHS Small Vessel Security Strategy*.

Reporting Suspicious Activities

Transport Canada believes the best way to keep small vessels and small vessel facilities secure is to promote security awareness. The Royal Canadian Mounted Police (RCMP) has a suspicious coastal activity awareness and reporting program. To learn about this program, search the Internet for RCMP suspicious coastal activity.

Reporting suspicious activities is important because the RCMP, provincial and municipal police need the marine community and people who live in remote coastal areas to be their eyes and ears. There is just too much navigable water within Canada and along our borders for the police to maintain marine security without help.

To learn more about Transport Canada Marine Security Activities, visit www.tc.gc.ca.

How You Can Help

We know that most people using small vessels and facilities are law-abiding, and that activities that appear suspicious may not be. Answer the questions below and use your best judgment to decide whether or not you should report what you may see.

- Are unauthorized persons trying to gain access to vessels or facilities?
- Are a vessel's crew members not typical for the type of small vessel?
- Are crew members reluctant to leave a vessel while it is being serviced and/or are they taking unusual security measures?
- Is a vessel anchored or running without lights in the dark?
- Are there smaller vessels hovering near a larger vessel?
- Are there lights flashing between boats?
- Are crew members recovering items from or tossing items into the water or onto the shoreline?
- Are people or things being transferred between vessels, between a vessel and a floatplane, or between a vessel and the shore?
- Are vessel owners reluctant to fully identify themselves to a marina or harbour authority? Is it hard for those authorities to locate owners?
- Do people appear too interested in potential targets such as hydro dams, power plants, chemical factories, bridges and key marine assets such as merchant vessels, ferries or cruise ships?
- Is there unusual diving activity?
- Has someone stolen a marine facility vehicle, vehicle pass, personnel identification or personnel uniforms?
- Do vessels appear to be purposely avoiding other vessels by changing direction?

Do not approach or challenge anyone you think is suspicious. Report suspicious activity to your local police service or call the RCMP at one of the telephone numbers in the **CONTACT INFORMATION AND REFERENCES** section of this guide.

RESPECT AND PROTECT CANADA'S WATERWAYS

Canada's lakes, rivers and coastal waters are ours to share. Do your part to take good care of them so they can be enjoyed long into the future.

Do not pollute the water with things like oil, garbage, hydrocarbons and untreated sewage in inland waters. It is not just a trend – it is the law!

Canada has laws that protect our waterways and shorelines. Some apply to pleasure boating. You must know and obey the laws in force **wherever** you go boating.

Prevent Pollution

The *Vessel Pollution and Dangerous Chemicals Regulations* address major risks to the health of our waterways and shorelines such as sewage, garbage and hydrocarbons. Sewage contains, among other things, human or animal body waste, drainage and other waste from toilets.

Sewage Management Solutions

The *Vessel Pollution and Dangerous Chemicals Regulations* require that boats fitted with toilets be equipped with either a holding tank, a marine sanitation device or temporary storage. Make sure you comply.

Many sewage management equipment and solutions exist. Choose sewage management equipment that works for you.

Holding Tanks

A holding tank collects and stores sewage or sewage sludge. Remember you must empty it at approved pump-out facilities on dry land only. Make sure to follow pumping instructions and avoid using disinfectants that may be harmful to the environment.

Marine Sanitation Devices

A marine sanitation device is designed to receive and treat sewage on board. Only sewage treated with a marine sanitation device that meets the standards set out in the regulations may be discharged in inland waters.

Temporary Storage

A porta pottie is considered a temporary storage. The only vessels that may use temporary storage on board are those that:

- are under 15 GT;
- carry no more than 15 persons;
- do not operate on inland waters.

When planning your trip, check with local authorities for pump-out facility locations.

Reduce Pollution from Bilges

Oil, fuel, anti-freeze and transmission fluid are a few examples of pollutants that harm the environment when pumped overboard – usually by automatic bilge pumps. Bilge cleaners, even the biodegradable ones, just break down the oil into tiny, less visible droplets – but it is still present. Absorbent bilge cloths are very useful because they are designed to absorb petroleum products and repel water.

Here are a few tips to help keep bilge pollution at a minimum:

- Make sure your bilge is clean before you turn on automatic bilge pumps. Only use them when needed and when the bilge contains only water.
- Use towels or bilge cloths to absorb oils, fuel, anti-freeze and transmission fluid. Dispose of used towels or bilge cloths in an approved garbage container.

Help Keep Out the Invaders

Invasive exotic species are plants, fish, shellfish and even tiny algae or bacteria that enter into waters that are not their natural home. They then multiply and crowd out the plants and animals that do belong there. Many have seen invasive species, such as zebra mussels and green crab, take over local waters.

You can do your part by keeping your hull clean. This is very important if you operate your boat on a lake or river and then tow it over land to use in another area. Rinsing or cleaning your hull after use or before entering new waters helps to remove spores and other invasive organisms. Some communities require this in their local bylaws.

Remember that dumping live bait, such as fish bait or crayfish in a lake is one way you risk bringing invaders into an area where they do not belong. This can cause serious harm to the food chain and local ecosystem.

To learn more about aquatic intruders, read *Aquatic Invasive Species – Identification Booklet*.

Use Environmentally Friendly Cleaners

All-purpose cleanser

Mix 30 ml of baking soda or borax, 30 ml of tea tree essential oil, 125 ml of vinegar, 15 ml of biodegradable dish soap and 2 litres of hot water. Spray on the surfaces you plan to clean.

Chromium

Rub with baking soda. Rinse and polish with vinegar in hot water.

Deck and floor

Pour 250 ml of vinegar in 2 litres of water.

Drain

Pour 60 ml of baking soda in the drain, followed by 60 ml of vinegar. Let it rest for 15 minutes, then pour in a full kettle of boiling water.

Mold

Add 60 ml of borax and 30 ml of vinegar to 500 ml of hot water. Spray the mixture to eliminate germs.

Toilet

Pour 125 ml of baking soda and 125 ml of vinegar into the toilet bowl. The foaming reaction cleans and deodorizes. Brush and flush.

Window and mirror

Mix 2 ml of liquid soap, 45 ml of vinegar and 500 ml of water in a spray bottle. Use a cotton rag to clean and shine.

Wood (polish)

Mix 30 ml of edible linseed oil, 30 ml of vinegar and 60 ml of lemon juice in a glass pitcher. Rub the solution into the wood with a soft rag until it is clean. To store the solution, add a few drops of vitamin E from a capsule and cover.

Green Boating Tips

- Make sure your engine is well maintained to reduce air pollution.
- Use only paints approved for marine use.
- When fuelling, do not top off tanks and clean up any spilled fuel.
- Keep your bilge clean and do not pump oily water overboard.
- Use bilge absorbents in place of detergents.
- Do not pump your sewage over the side – use a holding tank.
- Obey all sewage regulations.
- Bring your garbage home (including cigarette butts) – do not litter.
- Try not to use detergents – even biodegradable cleaners are hard on plants and animals that live in the water.
- Avoid shoreline erosion – watch your wake and propeller wash.
- Obey all speed limits for better fuel economy.
- Report pollution when you see it.

If you accidentally pollute the water or you witness or see the result of someone else polluting, report it to a Government of Canada pollution prevention officer or call one of the telephone numbers identified in the **CONTACT INFORMATION AND REFERENCES** section of this guide.

KNOW THE RESTRICTIONS THAT APPLY

Local restrictions may be in force on some Canadian waterways to promote public safety, and protect the public interest as well as the environment. Some of these include a ban on power boats, maximum engine power limits, speed limits and a ban on recreational towing activities. These restrictions are listed in the schedules to the Vessel Operation Restriction Regulations. Local authorities are responsible for implementing these regulations.

Province-Wide Shoreline Speed Limits

Some provinces have adopted speed limits of 10 km/h within 30 m (98'5") of shore on all waters within their boundaries. This speed limit applies in Ontario, Manitoba, Saskatchewan, Alberta and the inland waters of British Columbia and Nova Scotia. This limit is in effect whether it is posted or not. Exceptions include:

- recreational towing while traveling perpendicular from the shore;
- rivers less than 100 m (328') wide, as well as canals and buoyed channels; and
- waters where another speed limit is set in a schedule to the regulations.

New Restrictions

If you feel a restriction is needed in your area, read the Local Authorities' Guide. Before your request can be added to the Vessel Operation Restriction Regulations, the need for the restriction must be assessed and public consultations held at the local level. If successful, local authorities are responsible for all sign and buoy maintenance and replacement, including all costs.

Once a vessel operation restriction is in place, it can be enforced (in the form of tickets or summons) by:

- police officers; and
- persons identified in the regulations.

Failure to comply can result in fines.

KNOW HOW TO READ A RESTRICTION SIGN

Vessel operation restriction symbols come in five shapes. The colour of the frame is international orange. When part of a symbol has a green border, a special condition applies to the restriction. The symbol tells you the type of restriction that applies. If it is arrow-shaped, the restriction applies in the direction of the arrow. Know what these symbols mean.



No motorized vessels
(including power-driven and electric powered vessels)



No power-driven vessels
(vessels propelled by an internal combustion engine or a steam engine)



No recreational towing activities north
of the sign



No motorized vessels
(including power-driven and electric powered vessels) between the hours
and days in red



Speed limit



No sporting, recreational, or
public event or activity



Combined symbol
(no recreational towing activities
and speed limit)



No vessels



Power limit
(in public parks and controlled bodies
of water only)



No towing activities



No motorized vessels (including power-driven and electric powered vessels)
in the direction indicated by the arrow

BE READY TO COMPLY



Safety is a shared responsibility of Canadian waterway users and the organizations that govern them. Boaters must operate their boats safely. This means you must learn and follow the rules that apply to your boat as well as to the waters where you will be boating. The previous sections of this guide provided you with an overview of the laws and regulations that apply to pleasure boating.

The Royal Canadian Mounted Police (RCMP), provincial and municipal police forces and other authorized local authorities enforce the laws that apply to boats. They may inspect your boat and monitor your boating activities to make sure that you meet requirements that apply. This may include checking for safety equipment, your Pleasure Craft Operator Card and careless operation on the water.

Transport Canada's Office of Boating Safety helps boaters learn about boating laws with the help of tools like this guide. However, it is important to remember that these laws only set minimum requirements. Many boaters go above and beyond these laws to enhance the safety of their boat and guests, and Transport Canada encourages everyone to do the same.

Boating Offences and Associated Fines

Here is a list of some boating offences and their fines as presented in the *Contraventions Regulations*. Note that they do not include administrative charges.

Operating a vessel if you are under age	\$ 250
Failing to have proof of competency on board	\$ 250
Failing to have the required pleasure craft licence on board	\$ 250
Altering/Defacing/Removing hull serial number	\$ 350
Operating a boat in a careless manner, without due care and attention for others	\$ 350
Operating a vessel with safety equipment not in good working order or not readily accessible and available for immediate use	\$ 200
Operating human-powered pleasure craft without PFDs or lifejackets of appropriate size for each person on board (\$200). (Plus \$100 for each PFD or lifejacket missing.)	\$ 200 + \$ 100
Operating a power-driven vessel without a muffler that is in good working order	\$ 250
Operating a vessel to tow a person on water or in air without seating space on board for every person being towed	\$ 250
Operating a vessel to tow a person on water or in air without a person on board other than the operator keeping watch on every person being towed	\$ 250
Operating a vessel in an unsafe manner	\$ 500

You should also know that some boating offences can result in fines to both the operator of the boat as well as to its owner. An example of this would be allowing someone under the age of 16 to operate your PWC.

Fine amounts are subject to change. You can find a complete list of boating offences and current fines under the *Contraventions Regulations*.

Visitors to Canada



All boaters (both residents and visitors) on Canadian waters should know and obey the rules that apply in Canada. However, if you are a non-resident of Canada and are operating a boat in Canadian waters, the exceptions below apply to you.

Operator Competency

Operating your boat in Canada for less than 45 consecutive days

If you are a non-resident visiting Canada with your boat, you are not required to carry proof of competency on board as long as your boat is in Canada for less than 45 consecutive days.

Operating your boat in Canada for 45 consecutive days and more or operating a boat licensed or registered in Canada

If you are operating your boat in Canada for 45 consecutive days and more or operating a boat licensed or registered in Canada, you are required to carry a proof of competency, either an operator card or similar proof of competency issued by your home state or country.

REMEMBER: As a visitor, remember that you must keep proof of residence on board with you at all times.

Safety Equipment Requirements

Boats licensed or registered in a country other than Canada

Foreign boats (those that are licensed or registered in a country other than Canada) need to comply with the equipment requirements of the country in which the boat is usually kept.

Boats licensed or registered in Canada

If you are a non-resident of Canada operating a boat that is licensed or registered in Canada, the boat must meet Canadian safety equipment requirements. However, in either case, you may bring your own lifejacket or PFD to use as long as it fits and meets the requirements of your home country.

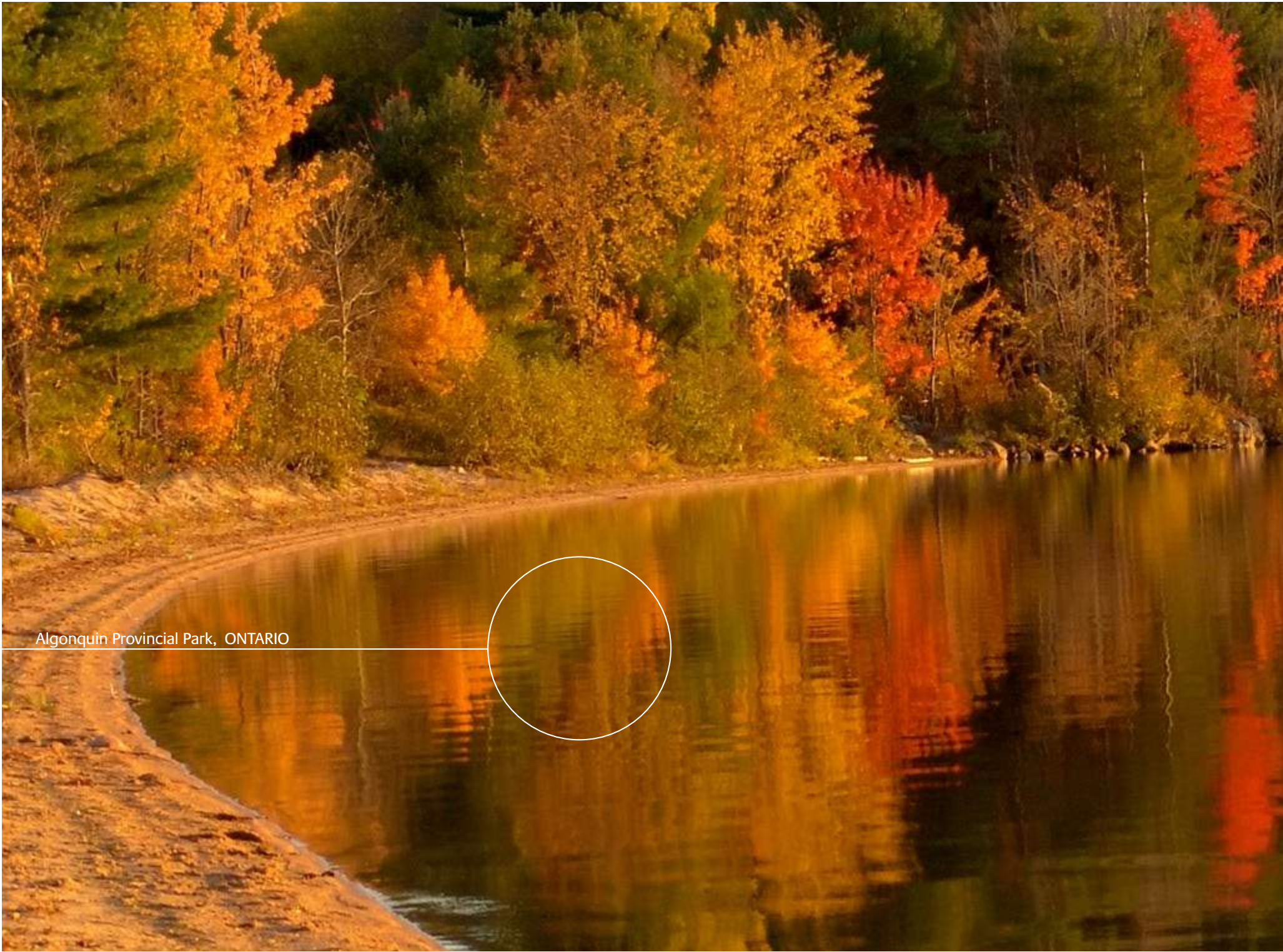

Algonquin Provincial Park, ONTARIO



IN AN EMERGENCY

Are you ready to deal with an emergency? Do you know how to send a distress message? Calling early and knowing how to ask for help in an emergency can make the difference between life and death. This section explains some of the equipment you can use to call for help and what to do in some emergencies.

COMMUNICATE EFFICIENTLY

Marine Radio Communications

Regulated marine radio communication equipment includes :

- Marine VHF radios (with the new Digital Selective Calling (DSC) option on channel 70);
- Marine MF/HF – DSC radios;
- Emergency Position Indicating Radio Beacons (EPIRBs);
- NAVTEX; and
- Inmarsat.

These products and services work together to form the international system known as the Global Maritime Distress and Safety System (GMDSS). They quickly relay distress alerts to the Canadian Coast Guard and other vessels in your area.

Pleasure craft are not required to carry GMDSS-compatible equipment, but it is a good idea. If you have it, connect it to a Global Positioning System receiver to make sure that your exact location is automatically sent in a digital distress alert in case of an emergency. This way, rescuers will immediately know exactly where you are and will arrive sooner.

Marine VHF Radio and the Maritime Mobile Service Identity (MMSI)



Marine VHF radio is generally the best way to send a distress alert. If you have a VHF radio, keep it tuned to channel 16. Know where you are at all times and be prepared to describe your specific location.

All VHF marine radio operators must have a Restricted Operator Certificate - Maritime – (ROC-M). Industry Canada has delegated the ROC-M to the Canadian Power and Sail Squadrons (CPS). Contact the CPS for information about courses available in your area.

If you are buying a new VHF radio, make sure it has the new Digital Selective Calling (DSC) feature on channel 70. This provides automatic digital distress alerts. The Canadian Coast Guard provides DSC channel 70 service on the east and west coasts, as well as on the Great Lakes and the St. Lawrence River.

REMEMBER: VHF radio channel 16 is used for emergency and calling purposes only.

Once you contact another vessel on channel 16, switch to another working frequency. VHF channel 70 is used only for DSC (digital) communication – not voice. Use your VHF radio as described in the VHF Radiotelephone Practices and Procedures Regulations. Your owner's manual will explain how to make a DSC call to another vessel or to a shore station with DSC.

To make a digital call, each radio must have a nine-digit Maritime Mobile Service Identity (MMSI) number. Industry Canada assigns these numbers free of charge. Visit their website (see **CONTACT INFORMATION AND REFERENCES** section of this guide) to learn more.

Calling for Help

When in extreme danger

When in extreme danger (for example, your boat is taking on water and you are in danger of sinking or capsizing), use your VHF radio channel 16 and say “Mayday” — “Mayday” — “Mayday.”

If you need help but are not in immediate danger

If you need help but are not in immediate danger (for example, your motor has quit and you cannot reach shore), use channel 16 and say “Pan-Pan” — “Pan-Pan” — “Pan-Pan.”

In both scenarios, then give the following information:

- the name of your boat;
- your position;
- the nature of your problem; and
- the type of help you need.

Post these guidelines near your radio.

Use of a Cell Phone

While you may be able to get search and rescue assistance from the nearest [Canadian Coast Guard Marine Communications and Traffic Services \(MCTS\) centre](#) by dialing *16 or #16 on a cell phone, it is not a good substitute for a marine radio and this is not the best way to issue distress call.

Why not?

- Cell phones can lose reception or get wet and damaged.
- Calling from your cell phone does not alert nearby vessels that you are in distress – they could be the ones to help you if they could hear you.
- Some cell phone signals cannot be followed back to your location by rescuers.
- Not all cell providers offer the *16 or #16 service.

Emergency Position Indicating Radio Beacons (EPIRBs)

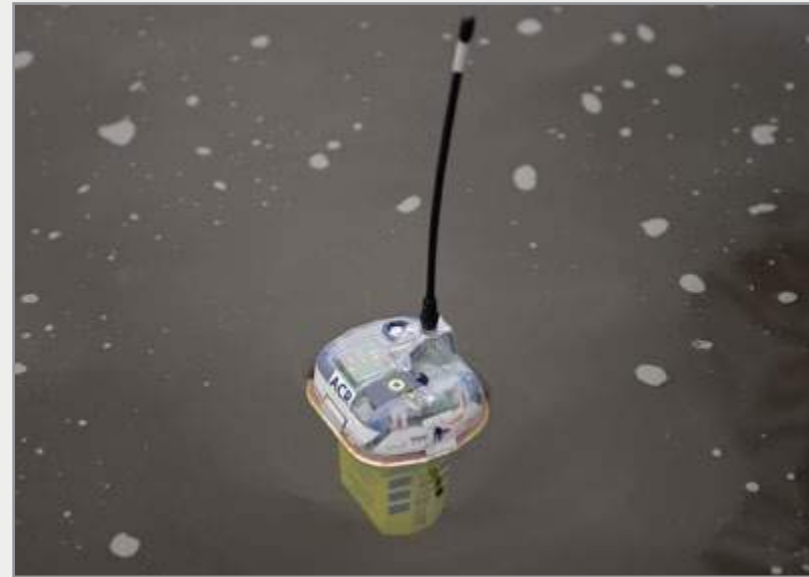

These floating radio distress beacons can transmit for hours. They can be manually activated or can float free from a sinking or overturned vessel. Their signals give your position to a network of satellites, which then sends it to Joint Rescue Coordination Centres. They play an important role in an emergency. Although pleasure craft are not required to carry them, they are a very good idea.

REMEMBER: As of February 1, 2009, only 406 MHz beacons will work on the water. All beacon owners and users should take steps to replace their 121.5/243 MHz beacons with 406 MHz beacons as soon as possible.

You must register your Emergency Position Indicating Radio Beacon (EPIRB) with the [Canadian Beacon Registry](#). Remember to keep your contact information up to date.

Distress Signals

If you see a distress signal, the law requires you to see if you can help without risking your life or the safety of your boat. When possible, you must also contact the nearest Joint Rescue Coordination Centre (see **CONTACT INFORMATION AND REFERENCES** section of this guide) to inform them of the type and location of the distress signal you have seen.

Learning the common distress signals will help you quickly recognize when someone is in trouble so that you can quickly place a call for help.

Never send a distress signal unless you are in a real emergency. Sending false distress signals is against the law. It wastes the time of search and rescue personnel and may prevent them from answering, or take them farther away from, real emergencies.

Canadian Coast Guard

VHF/DSC radios can send distress alerts that tell the Canadian Coast Guard and nearby vessels that you need help right away. To find out where VHF/DSC services are available, visit www.ccg-gcc.gc.ca or contact a Canadian Coast Guard Marine Communications and Traffic Services (MCTS) centre.

MCTS centres provide Vessel Traffic Services (VTS) and a Maritime Mobile Safety Service. VTS provides traffic and waterway information to vessels via radio communication.

When near a VTS area, listen to the local VTS radio frequency to learn the intended movements of larger vessels.

MCTS centres also provide a safety service that monitors international distress and calling radio frequencies for distress calls and communications needs.

They also continuously broadcast *Notices to Shipping* and weather and ice reports on marine radio frequencies. These are published along with the VTS sector frequencies in the Canadian Coast Guard publication *Radio Aids to Marine Navigation*. You can purchase this publication from an authorized chart dealer.

Global Positioning System (GPS)



While more and more boat operators rely on marine GPS to tell them where they are on the water, it is a good idea to keep charts on board in case the GPS fails. The GPS is a worldwide radio-navigation system made possible by a network of satellites and monitoring stations. Its receivers can calculate where you are, anywhere on the planet, to within 30 m (98' 5"). The Canadian Coast Guard supplies a differential GPS that provides an accuracy of within 10 m (32' 10").

If you are using GPS on the water, make sure it is marine GPS. Automotive GPS will not give you the information you need on the water.

BE PREPARED TO REACT TO AN EMERGENCY

Recovering Someone who Fell Overboard

Could you get a person out of the water if they could not help you?

If you fell overboard, could your guests lift you to safety?

In certain weather conditions, and on some boats, it is a good idea to wear a quick release safety harness and a safety line secured to your boat. This keeps you from falling overboard, unless your boat capsizes. Knowing and practicing the procedures below with your guests will help them stay calm in an emergency.

If someone falls overboard, sound the alarm and then:

- slow down, stop if possible, and throw something that floats to the person (this will also mark the spot if they are under water);
- assign someone to watch the person overboard;
- carefully put your boat in position to bring the person back on board; and
- use a heaving line that floats, or a lifebuoy secured to the boat with a line, and recover the person from the windward side.

REMEMBER: If needed, you can secure both ends of a heavy rope, chain or cable to the boat and drape it over the side (almost touching the water) as a makeshift step. Remember that if the vertical height that someone must climb to reboard your boat from the water (freeboard) is over 0.5 m (1'8"), you must have a reboarding device, such as a ladder.

Boaters should know of, and be able to use, a few different methods to recover someone who has fallen overboard. They should also be able to decide which method to use based on the conditions of both the water and the person overboard.

When someone's size, or the freeboard of the boat, makes it difficult to carry out a rescue by hand, it may be a good idea to have lifting slings and rigging on board (if not already required by the size of your boat).

Surviving in Cold Water

Imagine that you are enjoying a warm day on your boat. You get up to grab something. Suddenly, you lose your balance and fall into water that is less than 15°C. Cold water can paralyze your muscles instantly. Sadly, many people do not understand this danger and how important it is to avoid it.

Cold Water Shock

Cold water shock likely causes more deaths than hypothermia. Canada's cold waters are especially dangerous when you fall into them unexpectedly. For three to five minutes, you will gasp for air. You could also experience muscle spasms or a rise in your heart rate and blood pressure. Worse yet, you could choke on water or suffer a heart attack or a stroke.

REMEMBER: Even strong swimmers can suffer the effects of cold water shock.

If you are wearing a lifejacket or PFD before falling into cold water, it will keep you afloat while you gain control of your breathing and prevent drowning from loss of muscle control. Trying to grab a lifejacket or PFD while in the water, let alone putting one on, will be very hard because of the changes your body will be experiencing.

Swimming Exhaustion



If you survive the shock of cold water, **swimming exhaustion** is the next danger. The longer you are in cold water, the harder it is to coordinate your movements. You will grow weaker and soon have difficulty holding onto the craft, putting on your lifejacket or PFD or even handling flares.

Hypothermia

If you survive the first two stages of immersion in cold water, you are at risk of **hypothermia**. This occurs when your body's temperature dips below 36°C. Hypothermia affects a person's control over his or her muscles and thinking. Someone who is exposed to cold water and becoming hypothermic might:

- shiver, use slurred speech and become semi-conscious;
- have a weak, irregular or no pulse;
- breathe slowly;
- lose control of body movements;
- behave in ways that do not make sense;
- act confused and/or sleepy;
- stop breathing; and
- become unconscious.

Tips on Surviving in Cold Water

If you end up in the water, do everything you can to save your energy and body heat. Swim only if you can join others or reach safety. **Do not swim to keep warm.**

You may survive longer in cold water if you:

- wear a Canadian-approved lifejacket or PFD so that you will not lose valuable energy trying to keep your head above water;
- climb onto a nearby floating object to get as much of your body out of or above the water as possible;
- cross your arms tightly against your chest and draw your knees up close to them to help you keep your body heat;



- huddle with others with chests close together, arms around mid to lower back, and legs intertwined.



If you have warning that your boat may sink, protect yourself from the cold by wearing multiple light layers of dry clothing and a water or windproof outer layer under a lifejacket or PFD.

Extra protection from hypothermia includes:

- **floaters or survival suits** (full nose-to-toes);
- **dry suits** (to be used with a lifejacket or PFD and a thermal liner);
- **wet suits** (to be used with a lifejacket or PFD – trap and heat water against the body); and
- **immersion suits** (to be used in extreme conditions when abandoning a vessel).

Knowing how your safety equipment works, especially in water, is a good idea. Test it in a warm swimming pool or in calm water before you may have to use it in an emergency.

For more information, or to see what really happens during cold water immersion, visit www.coldwaterbootcamp.com.

Reacting to a Fire

If you have a fire on board, make sure everyone is wearing a lifejacket or PFD and use extinguishers to control the fire.

In case of a small fire, activate a fire extinguisher and aim it at the base of the flames. Sweep the discharge nozzle from side to side and for a few seconds after the flames are completely out. Otherwise, the fire may restart and there might not be enough left in the extinguisher to put it out again.

If your boat is moving when a fire starts, position it so the fire is downwind from you and stop the engine if it is safe to do so under the weather conditions.

Even if your boat has an automatic fire extinguishing system, it must also carry the required portable extinguishers listed in the **SAFETY EQUIPMENT REQUIREMENTS** section. You can get more information on their care and maintenance from *Underwriters' Laboratories of Canada (ULC)* or the manufacturer.



Lund Harbour, BRITISH COLUMBIA



CONTACT INFORMATION AND REFERENCES

Looking for more information? This section provides contact information for Transport Canada, as well as for some other organizations mentioned in this guide. It also provides direct website links to specific topics and publications on boating safety.

CONTACT INFORMATION

Transport Canada

www.tc.gc.ca

Office of Boating Safety

www.tc.gc.ca/boatingsafety

1-800-267-6687

Marine Safety and Security

Marine Safety: www.tc.gc.ca/marinesafety

Marine Security: www.tc.gc.ca/eng/marinesecurity/menu.htm

Vessel Registration Office

www.tc.gc.ca/eng/marinesafety/oep-vesselreg-menu-728.htm

1-877-242-8770

Other Federal Departments and Organizations

Canada Border Services Agency

www.cbsa-asfc.gc.ca/

Canadian Beacon Registry

www.cbr-rcb.ca/cbr/

Canadian Coast Guard

Marine and Air Search and Rescue Emergency Centres

www.ccg-gcc.gc.ca/eng/CCG/SAR_Rescue_Centre_Contact_Information

- **Pacific Coast**
Joint Rescue Coordination Centre Victoria
1-800-567-5111 or 1-250-363-2333

- **Great Lakes and Arctic**
Joint Rescue Coordination Centre Trenton
1-800-267-7270 or 1-613-965-3870
- **St. Lawrence River**
Maritime Rescue Sub-Centre Quebec
1-800-463-4393 or 1-418-648-3599
- **Newfoundland and Labrador Coast**
Maritime Rescue Sub-Centre St. John's
1-800-563-2444 or 1-709-772-5151
- **Maritimes Coast**
Joint Rescue Coordination Centre Halifax
1-800-565-1582 or 1-902-427-8200

Marine Communications and Traffic Services (MCTS) centre

www.ccg-gcc.gc.ca/Marine-Communications/Home

Reporting a Marine Pollution Incident

www.ccg-gcc.gc.ca/eng/Ccg/er_Reporting_Incident

- British Columbia and Yukon
1-800-889-8852
- Alberta, Saskatchewan, Manitoba, Ontario, Northwest Territories and Nunavut
1-800-265-0237
- Quebec
1-800-363-4735
- New Brunswick, Prince Edward Island and Nova Scotia
1-800-565-1633
- Newfoundland and Labrador
1-800-563-9089

Canadian Hydrographic Service

www.charts.gc.ca/

Environment Canada

www.ec.gc.ca/

Marine Forecast

http://weather.gc.ca/marine/index_e.html

Weather Services across Canada

<http://weather.gc.ca/>

Government of Canada Publications

www.publications.gc.ca

Industry Canada

www.ic.gc.ca

Integrated Terrorism Assessment Centre

www.itac.gc.ca/index-eng.asp

Parks Canada

<http://www.pc.gc.ca/>

Royal Canadian Mounted Police (RCMP)

Reporting Suspicious Marine Activities

<http://www.rcmp-grc.gc.ca/index.htm>

- Newfoundland and Labrador
1-709-772-5400
- Nova Scotia
1-800-803-7267
- Prince Edward Island
1-902-566-7112
- New Brunswick
1-800-665-6663
- Quebec
1-800-771-5401
- Ontario

1-800-387-0020

- Manitoba
1-204-983-5462
- Saskatchewan
1-306-780-5563
- Alberta
1-780-412-5300
- British Columbia
1-888-855-6655
- Yukon
1-800-381-7564
- Northwest Territories
1-867-669-1111
- Nunavut
1-867-979-1111

Service Canada

www.servicecanada.gc.ca/
1 800 0-Canada (1-800-622-6232)

Other Organizations

Canadian Power and Sail Squadrons

<https://www.cps-ecp.ca/public.asp>

Great Lakes St. Lawrence Seaway System

www.greatlakes-seaway.com/en/contact-us/index.html

International Maritime Organization

www.imo.org/Pages/home.aspx

Provincial and Territorial Transportation Offices

www.tc.gc.ca/eng/motorvehiclesafety/resources-links-index-47.htm#caprov

Underwriters Laboratories of Canada

<http://www.ul.com/canada/eng/pages/index.jsp?Scroll=1>

DOCUMENTS AND REFERENCES

Laws and Regulations

Canada Shipping Act, 2001

<http://laws-lois.justice.gc.ca/eng/acts/C-10.15/>

Canada's Criminal Code

<http://laws-lois.justice.gc.ca/eng/acts/c-46/>

Charts and Nautical Publications Regulations

<http://laws-lois.justice.gc.ca/eng/regulations/SOR-95-149/>

Collision Regulations

http://laws-lois.justice.gc.ca/eng/regulations/C.R.C.,_c._1416/

Competency of Operators of Pleasure Craft Regulations

<http://laws-lois.justice.gc.ca/eng/regulations/SOR-99-53/>

Contraventions Regulations

<http://laws-lois.justice.gc.ca/eng/regulations/SOR-96-313/>

Historic Canal Regulations

<http://laws-lois.justice.gc.ca/eng/regulations/sor-93-220/>

Navigation Safety Regulations

<http://laws-lois.justice.gc.ca/eng/regulations/SOR-2005-134/>

Small Vessel Regulations

<http://laws-lois.justice.gc.ca/eng/regulations/SOR-2010-91/>

Vessel Operation Restriction Regulations

<http://laws-lois.justice.gc.ca/eng/regulations/SOR-2008-120/>

Vessel Pollution and Dangerous Chemicals Regulations

<http://laws-lois.justice.gc.ca/eng/regulations/sor-2012-69/page-1.html>

VHF Radiotelephone Practices and Procedures Regulations

<http://laws-lois.justice.gc.ca/eng/regulations/SOR-81-364/>

OTHER REFERENCE TOOLS AND PUBLICATIONS

Approved Products Catalogue Index

<http://www.tc.gc.ca/eng/marinesafety/oeep-navigation-safety-apci-2298.htm>

Aquatic Invasive Species – Identification Booklet

http://publications.gc.ca/collections/collection_2013/mpo-dfo/Fs124-5-2013-eng.pdf

Cabinet Directive on Regulatory Management

<http://www.tbs-sct.gc.ca/rtrap-parfa/cdrm-dcgr/cdrm-dcgrtb-eng.asp>

Cold Water Bootcamp

<http://www.coldwaterbootcamp.com/>

Constructions Standards for Small Vessels – TP 1332E

<http://www.tc.gc.ca/eng/marinesafety/tp-tp1332-menu-521.htm>

Finding the Right Flotation Device

www.wearalifejacket.com

List of Lights, Buoys and Fog Signals

<http://www.charts.gc.ca/publications/lbfs-lfbsb-eng.asp>

Local Authorities' Guide – Vessel Operation Restriction Regulations (TP 14350E)

www.tc.gc.ca/boatingsafety

List of Marine Safety Certificates Recognized for the Issuance of a Pleasure Craft Operator Card

<http://www.tc.gc.ca/eng/marinesafety/debs-obs-courses-pcoc-list-marine-safety-certif-1323.htm>

Global Maritime Safety and Distress System (GDDSS)

www.ccg-gcc.gc.ca/eng/CCG/SAR_Gmdss

Marine Mobile Service Identity (MMSI) Number

www.ic.gc.ca/eic/site/smt-gst.nsf/eng/sf01032.html

Notices to Mariners

www.notmar.gc.ca/

Radio Aids to Marine Navigation – Find an authorized dealer

www.charts.gc.ca/publications/ramn-arnm-eng.asp

Sailing Directions

www.charts.gc.ca/publications/sd-in/sd-in-eng.asp

Transport Canada Accredited Course Providers

http://www.tc.gc.ca/eng/marinesafety/debs-obs-paperwork-paperwork_operator-3718.htm

DISCLAIMER: The links to external websites provided in this guide are for your convenience only. Be aware that they may not follow the *Official Languages Act*.

PRE-DEPARTURE CHECKLIST

Be prepared for the unexpected. Check this list before every trip.

Lifejackets and PFDs – Wear Them!

- Carry a Canadian-approved lifejacket or PFD of the proper size, for each person on board.
- Make sure they are in good condition (check the zippers, buckles, fabric, seams, etc.).

Operator Competency – Are You Ready to Head Out on the Water?

- Take a boating safety course.
- Always carry your Pleasure Craft Operator Card or other proof of competency on board.

Weather – Check and Monitor the Marine Weather Forecast

Sail Plan – File Your Plan Before Heading Out

- Use the sample [sail plan](#) in this guide.
- Tell a person you trust where you are going and when you will be back.

Safety Equipment – Required by Law and Essential for Safety

- See equipment required for your boat.
- Make sure all equipment is on board, in good working order and easy to reach.
- Carry a first aid kit, basic tools and spare parts.

Charts, Compass and Local Hazards – Know Where You Are at All Times

- Make sure you are aware of all local hazards, water levels and tides.

Fuel – Check Your Tank and Remember:

- 1/3 to go, 1/3 to return, 1/3 reserve .

Boat Condition – Should Your Boat Leave the Dock?

- Check the hull for cracks or other damage.
- Check the electrical, fuel, propulsion and cooling systems.
- Make sure the throttle and steering work well.
- Check the oil.
- Check all hoses and lines for leaks or cracks, and replace if necessary.
- Make sure all clamps and belts are secure and in good shape.
- Inspect, clean and replace spark plugs if necessary.
- Check and change oil and water filters if needed.
- Check the battery's charge.
- Make sure the drainage plug is in place.
- Carry spare plugs for all through hull fittings.
- Make sure the load on your boat (gear and people) is well distributed.
- Run the blowers for four minutes before starting the engine(s) and check for airflow.

Safety Briefing – You Are Legally Responsible for Your Guests

- Show everyone where you keep the safety equipment and explain how to use it.
- Make sure the communication equipment works and everyone knows how to use it.

SAIL PLAN

To make filing your sail plan easy, photocopy this card and fill in the blanks.

OWNER INFORMATION

Name:	
Address:	
Telephone Number:	Emergency Contact Number:

BOAT INFORMATION

Boat Name:		Licence or Registration Number:	
Sail:	Power:	Length:	Type:
Colour	Hull:	Deck:	Cabin:
Engine Type:		Distinguishing Features:	
Radio Channels Monitored:	HF:	VHF:	MF:
MMSI (Marine Mobile Service Identity) Number:			
Satellite or Cellular Telephone Number:			

SAFETY EQUIPMENT ON BOARD

Lifejackets and PFDs <i>(include number)</i> :
Liferafts <i>(include type and colour)</i> :
Flares <i>(include number and type)</i> :
Other Safety Equipment:

TRIP DETAILS (UPDATE THESE DETAILS EVERY TRIP)

Number of People on Board:	Search and Rescue Telephone Number:
Proposed Route	
Leaving From:	Date and Time of Departure:
Heading To:	Estimated Date and Time of Arrival:
Stopover Points (indicate date and time):	

LATERAL BUOYS

Port (green spar) Keep this buoy on your port (left) side when going upstream.

Bifurcation (red and green bands)
You may pass this buoy on either side when moving upstream. The colour of the top band shows which is the main or preferred channel. For example: keep this buoy on your starboard (right) side.

Port (green can)
Keep this buoy on your port (left) side when going upstream.

Port (green pillar)
Keep this buoy on your port (left) side when going upstream.

Starboard (red spar)
Keep this buoy on your starboard (right) side when going upstream.

Starboard (red conical)
Keep this buoy on your starboard (right) side when going upstream.

Starboard (red pillar)
Keep this buoy on your starboard (right) side when going upstream.

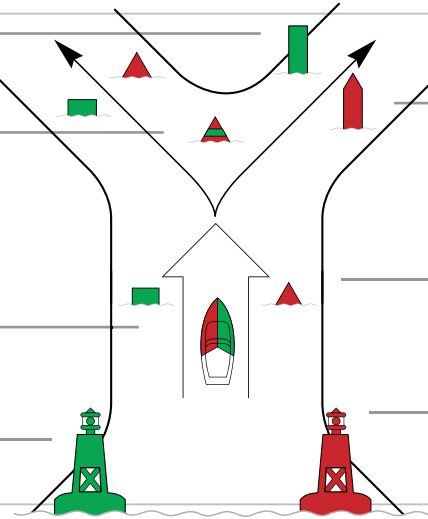

FAIRWAY

This buoy marks safe water at landfalls, channel entrances or channel centres. While you may pass it on either side, keep it on the port (left) side when going in either direction.

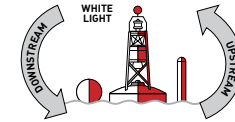

ISOLATED DANGER

This buoy marks an isolated danger, such as a small shoal or a wreck that has navigable water all around it. Consult the chart to learn the size, depth, etc. of the danger.

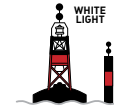

STANDARD DAYBEACONS

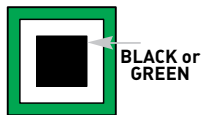

BLACK or GREEN

Port Hand

When going upstream, keep a port hand daybeacon on your port (left) side.



Starboard Hand

When going upstream, keep a starboard hand on your starboard (right) side.



Junction (Preferred channel to right)

This daybeacon marks a point where the channel divides and you may pass it on either side. If you want to take the channel to your right, keep this daybeacon on your port (left) side.

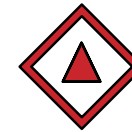

Junction (Preferred channel to left)

This daybeacon marks a point where the channel divides and you may pass it on either side. If you want to take the channel to your left, keep this daybeacon on your starboard (right) side.

CARDINAL BUOYS

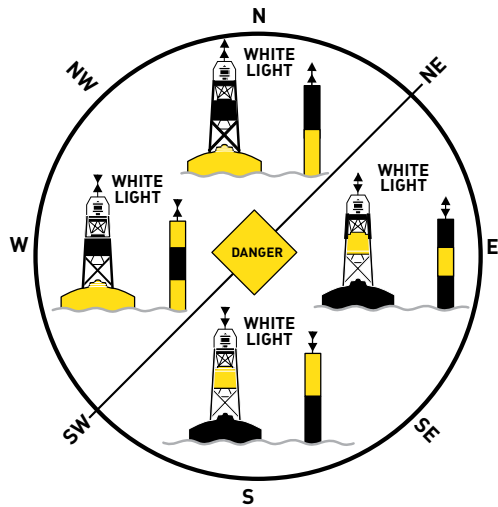

Topmarks

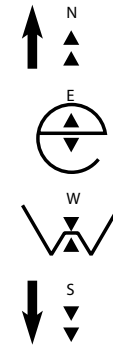

Description:

- Yellow and black
- White lights - See light flash characters indicated below (if equipped)
- The points of the two topmark cones tell you where to find safe water
- Topmark cones show where the black bands are placed on the buoy
- Letterhead - no numbers
- White retroreflective material









Light Flash Characters

NORTH	EAST	SOUTH	WEST
<p>0 sec 5 10 15 (Q) 1S</p>	<p>0 sec 5 10 15 (Q(3)10S</p>	<p>0 sec 15 (Q (6) + LFI) 15S</p>	<p>0 sec 15 Q(9)15S</p>
<p>0 sec 5 10 15 (VQ) .5S</p>	<p>0 sec 5 10 15 VQ(3)5S</p>	<p>0 sec 10 (VQ (6) + LFI) 10S</p>	<p>0 sec 10 VQ(9)10S</p>

SPECIAL BUOYS

Description

- Shapes have no special meaning
- May be lettered – no numbers
- Cautionary, scientific and anchorage buoys may display a yellow “X” topmark
- Yellow lights – flash characters (if equipped)
- Yellow retroreflective material

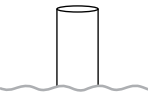
 <p>Cautionary</p> <p>A cautionary buoy marks dangers such as firing ranges, underwater pipelines, race courses, seaplane bases and areas where no through channel exists.</p>	 <p>Anchorage</p> <p>An anchorage buoy marks the outer limits of designated anchorage areas. Consult the chart for water depth.</p>	 <p>Mooring</p> <p>A mooring buoy is used for mooring or securing vessels. Be aware that when you see one, there may be a vessel secured to it.</p>	 <p>Information</p> <p>An information buoy displays information such as locality, marina, campsite, etc. inside the orange square.</p>	 <p>Hazard</p> <p>A hazard buoy marks random hazards such as shoals and rocks. You will find information illustrated inside the orange diamond.</p>
 <p>Control</p> <p>Obey the speed limits, wash restrictions, etc. are illustrated inside the orange circle.</p>	 <p>Keep out</p> <p>A keep out buoy marks areas your vessel may not enter.</p>	 <p>Scientific (ODAS)</p> <p>An ocean data acquisition system buoy collects weather and other scientific data.</p>	 <p>Diving</p> <p>A diving buoy marks an area where scuba or other such diving activity is in progress. You are not likely to find them on navigation charts.</p>	 <p>Swimming</p> <p>A swimming buoy marks the outer limits of swimming areas. It may not appear on your navigation charts.</p>

RULES OF THE ROAD

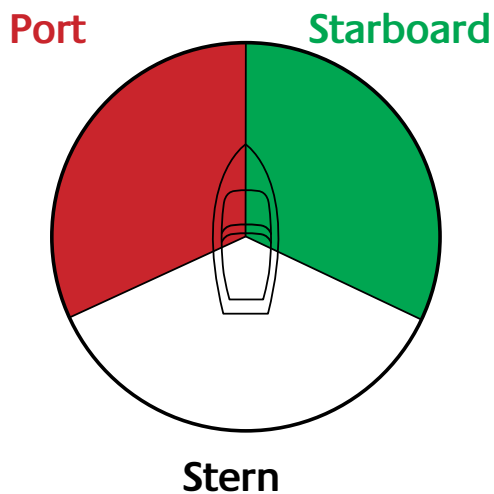

- Port** : If a power-driven vessel approaches within this sector, maintain your course and speed with caution.
- Starboard** : If any vessel approaches within this sector, keep out of its way. (Note: This rule may not always apply if one or both vessels are sail boats.)
- Stern** : If any vessel approaches this sector, maintain your course and speed with caution.



A blows one blast and alters course to starboard.
B blows one blast and alters course to starboard.

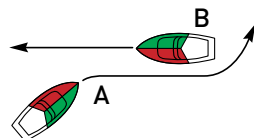

A keeps clear of and must avoid crossing ahead of B.

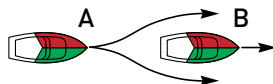

Any vessel overtaking another must keep clear.

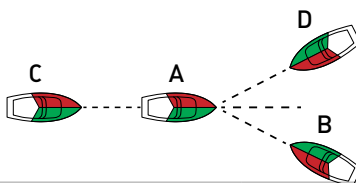

A keeps clear of B
B keeps clear of D
C keeps clear of A and B
D keeps clear of A and C

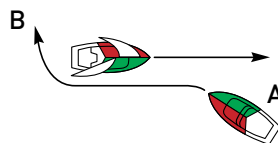

A power-driven vessel keeps clear of a sailing vessel.

1. When sailing vessels have the wind on different sides, the vessel with the wind on its port (left) side must keep out of the way of the other

Note : If a sailing vessel has the wind on its port (left) side and the operator is not sure if the other vessel has the wind on its port or starboard (right) side, the first boat must keep out of the way of the other.

Vessel A keeps clear of vessel B.

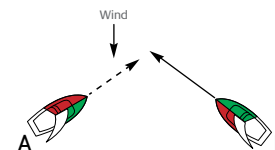

2. When both sailing vessels have the wind on the same side, the vessel to windward* must keep out of the way of the vessel to leeward.

** The windward side is opposite to the side that carries the mainsail or, in the case of a square-rigged vessel, the side opposite to the side that carries the largest fore-and-aft sail.*

As you can see, vessel B. keeps clear of vessel A.

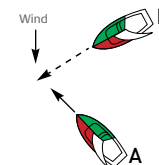

DISTRESS SIGNALS

MARINE RADIO

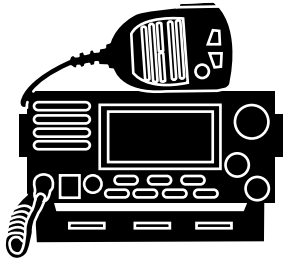

Distress call

- Use 2 182 kHz (MF) or channel 16, 156.8 MHz (VHF)
- DSC alert, channel 70 (only for DSC type radios and where the service is offered)

Calling procedures

- Immediate danger for persons or ship
“Mayday” — “Mayday” — “Mayday”
 - Give vessel name and call sign
 - State position of vessel
 - Describe nature of emergency
- Urgent message concerning safety of a person or ship
“Pan-Pan” — “Pan-Pan” — “Pan-Pan”
 - Give vessel name and call sign
 - State position of vessel
 - Describe nature of emergency

EMERGENCY POSITION INDICATING RADIOBEACON (EPIRBs)

Use alarm signal



DISTRESS CLOTH

To attract attention: spread on cabin or deck top, or fly from mast.



ARM SIGNAL

Keep raising and lowering outstretched arms.



CODE FLAGS

- N over C



- BALL over or under SQUARE



DYE MARKER



SOUND SIGNALS

Make continuous sound with any fog-signalling device. Fire a signal gun or other explosive signal at one-minute intervals.

FLARES

Type A: Parachute Rocket Flares
Type B: Multi-Star Flares
Type C: Hand-Held Flares
Type D: Smoke Signals (Buoyant or Hand-Held)

FLASHLIGHT

Other light source may be used.

